

# Structure of microfiche

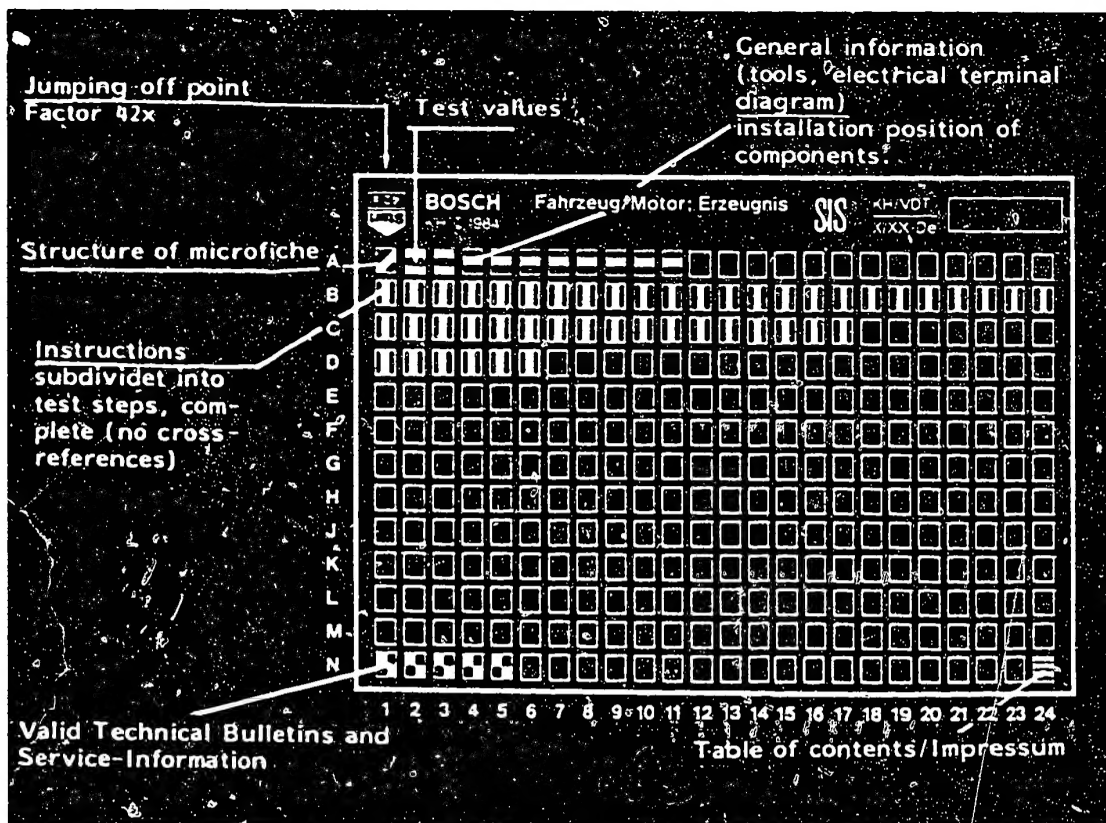

1. Read from left to right
2. Title of microfiche (appears on each coordinate)

<b>E16</b>	Product/component/test step
	Vehicle/engine

← Coordinate

3. Limits of section



Beginning

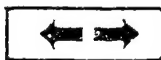

Mid-section



End

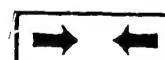

One-page section

4. References to relevant test steps in test specifications; coordinate e.g. C6

**C6**

**A1**

Trouble-shooting program



## 1. Test specifications - electrical

**D3**

No-load values:                      10.5 V  
   < 160 A  
   > 4200 min<sup>-1</sup>

**D6**

### Short-circuit values

In testing with 2 x 134 Ah batteries connected in parallel, and 10 m Ω resistor in series (EFAL 152/153).

V	A	Md <sup>1)</sup>
3.0 V	720 - 950 A	25 Nm
2.4 V	580 - 750 A	18 Nm

**D6**

### Short-circuit values

When testing with 1 x 143 Ah battery and 10 m Ω resistor in series

V	A	Md <sup>1)</sup>
2.8 V	660 - 810 A	24 Nm
2.2 V	520 - 690 A	17 Nm

**D2**

### Minimum pull-in voltage

For tooth/tooth wiring

(max. retraction travel of pinion 2 mm) ≤ 7.8 V

1) Only for test benches with torque meter

**A2**

Test specifications - electrical  
EV-type starting motor 0 001 218 ..



## 2. Test specifications - mechanical

Commutator $\beta$	new	minimum	<b>B 19</b>
	30.0 mm	28.9 mm	
Minimum length of carbon brushes:	7 mm		<b>C 1</b>
Longitudinal play of armature:	0.05 ... 0.3 mm		<b>C 14</b>
Run out			<b>B 21</b>
Commutator:	0.01 mm		
Laminated core:	0.05 mm		
Armature braking torque:	1.0 - 1.5 Nm		<b>C 17</b>
Overrunning torque:			<b>C 10</b>
Outside diameter:	53.5 mm:	0.14...0.22 Nm	
of the free-wheel:	57.5 mm:	0.27...0.35 Nm	
Tooth backlash:	0.3 ... 0.6 mm		<b>D 4</b>
Pinion clearance:	2.0 ... 3.0 mm		<b>D 5</b>

**A3**

Test specifications - mechanical

EV-type starting motor 0 001 218 ..

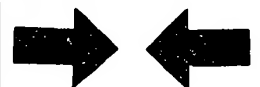

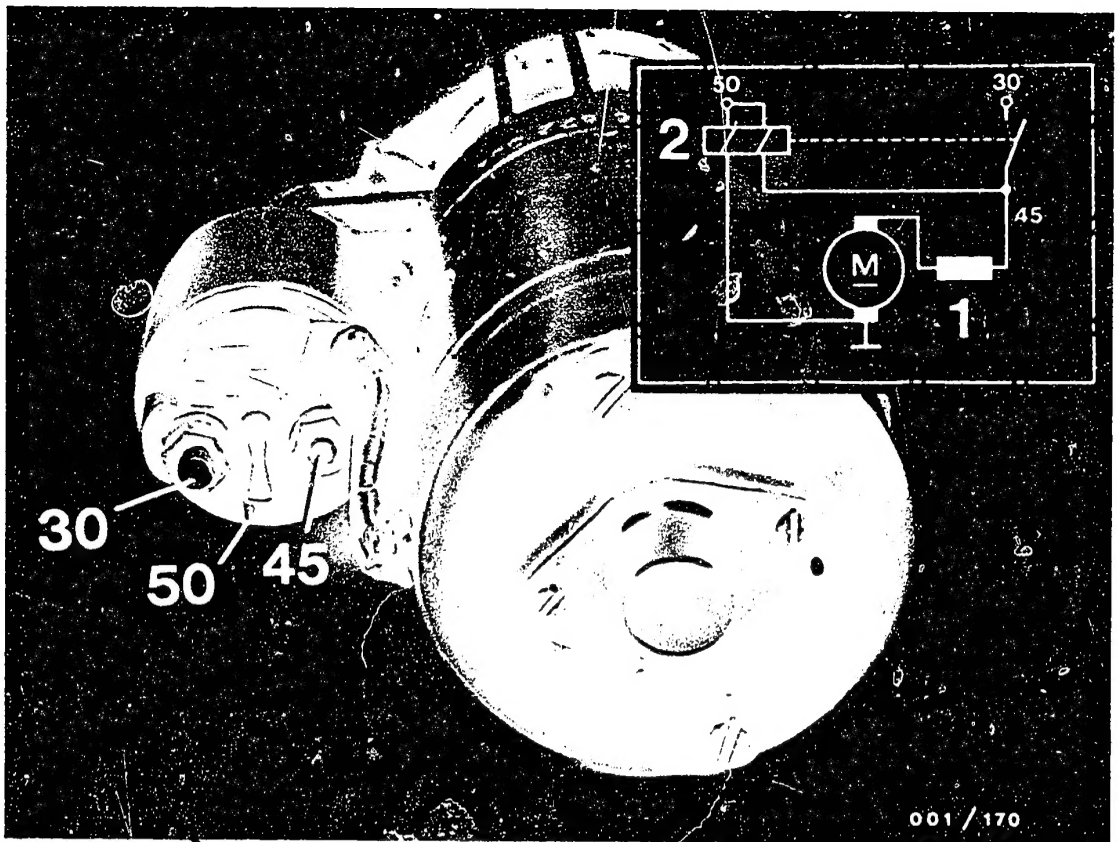

001 / 170

1 = Exciter winding

2 = Solenoid switch

3. Illustration of connections and circuit diagram

**A4**

Circuit diagram, terminal designations  
EV-type starting motor 0 001 218 ..



#### 4. General information

- 4.1 The lubricants specified in this manual must be used in order to guarantee proper operation.
- 4.2 Professional repair work can only be performed using specified tools and accurate measuring instruments. We therefore recommend that only the stated tools be used.
- 4.3 The sintered bushings in the drive-end-bearing housing/commutator end shield and pinion must always be renewed whenever repairs are carried out.

#### Note:

Do not connect the starting motor incorrectly for the electrical test!

(Housing to ground, + 12 V to Connection 30 on the relay).



#### 4.5 Clean the parts

Clean the armature, the exciter windings, the overrunning gears, and relay only with compressed air (max. 4 bar) and clean cloths. Do not use any liquid cleaning agent.

Other parts, such as screws, the hollow wheel, and the drive shaft can be washed out in a non-combustible commercially-available cleaning fluid.  
In so doing, do not inhale the fumes.

#### Caution!

Parts which have been washed must be dried thoroughly since otherwise gases may form later in the starting motor when it has been sealed - danger of explosion-like detonation.

#### Observe the following safety regulations:

Decree on Working with Combustible Liquids (Vbf) issued by the Federal Ministry of Labour (BmA).

Safety Regulations for Handling Chlorinated Hydrocarbons:

for the workshop      ZH 1 / 222  
for the employee      ZH 1 / 119

issued by the Central Association of German Employers' Liability Insurance Associations (Central Association for Accident Prevention and Industrial Medicine),  
Langwartweg 103, 5300 Bonn 5.

In countries outside the Federal Republic of Germany, observe the corresponding local regulations.

**A6**

General instructions

EV-type starting motor 0 001 218 ..



## 5. Necessary test equipment and tools

Test panel	(EFAW 81)	0 681 169 013
Transformer panel	(EFAW 82)	0 681 169 014
Interturn-short-circuit tester	(EFAW 90)	0 681 169 034
or	(EFAW 95)	0 681 169 020
Electrics tester	ETE 014.00	0 684 101 400
or		
Multimeter		Commercially available
Torque wrench		Commercially available
Arbor press		Commercially available
Mounting sleeve (for 12 mm dia.)		KDAL 5028
Mounting base		KDAL 5047
Assembly tool (for brush plate)		KDAL 5050
Plug gauge 8.1 mm		KDAL 5049
Tailstock steadies for holding armature when turning down commutator		
with Morse taper 2		KDAW 9987
with Morse taper 3		KDAW 9990
Undercutting saw		KDAW 9998
Clamping support		KDAW 9999
Press-in mandrel for pole shoes		User-fabricated
	$D = 50.7_{-0.06}^{-0.01}$ mm	
	L = 85 mm	



Necessary tools (continued)

Torquemeter	0.04 ... 0.12 Nm	KDAL 5482
	0.15 ... 0.8 Nm	KDAL 5485

Spring scale	2 ... 12 N	KDAW 9991
	5 ... 20 N	KDAW 9993
	15 ... 50 N	KDAW 9992

Puller

Base part KDEP 1056/10

Spring collet 12.0 ... 12.5 mm dia. KDAW 5493/0/3





6. Lubricants

Special lubricating grease

for roller-bearings and intermediate transmission

500g can (VS 10 832 Ft) 5 932 240 150

Special lubricating grease

for planetary gears

(DOW Corning x5 - 7514)

5 899 907 318

Silicon oil

for heavily stressed bearing points

0.50 l can (VS 13834 0I) 5 962 260 605

Silicon grease

High quality Lubricating grease with  
high pressure additives (Ft 2 v 3)

50 g tube

5 700 082 005

250 g tube

5 700 082 025



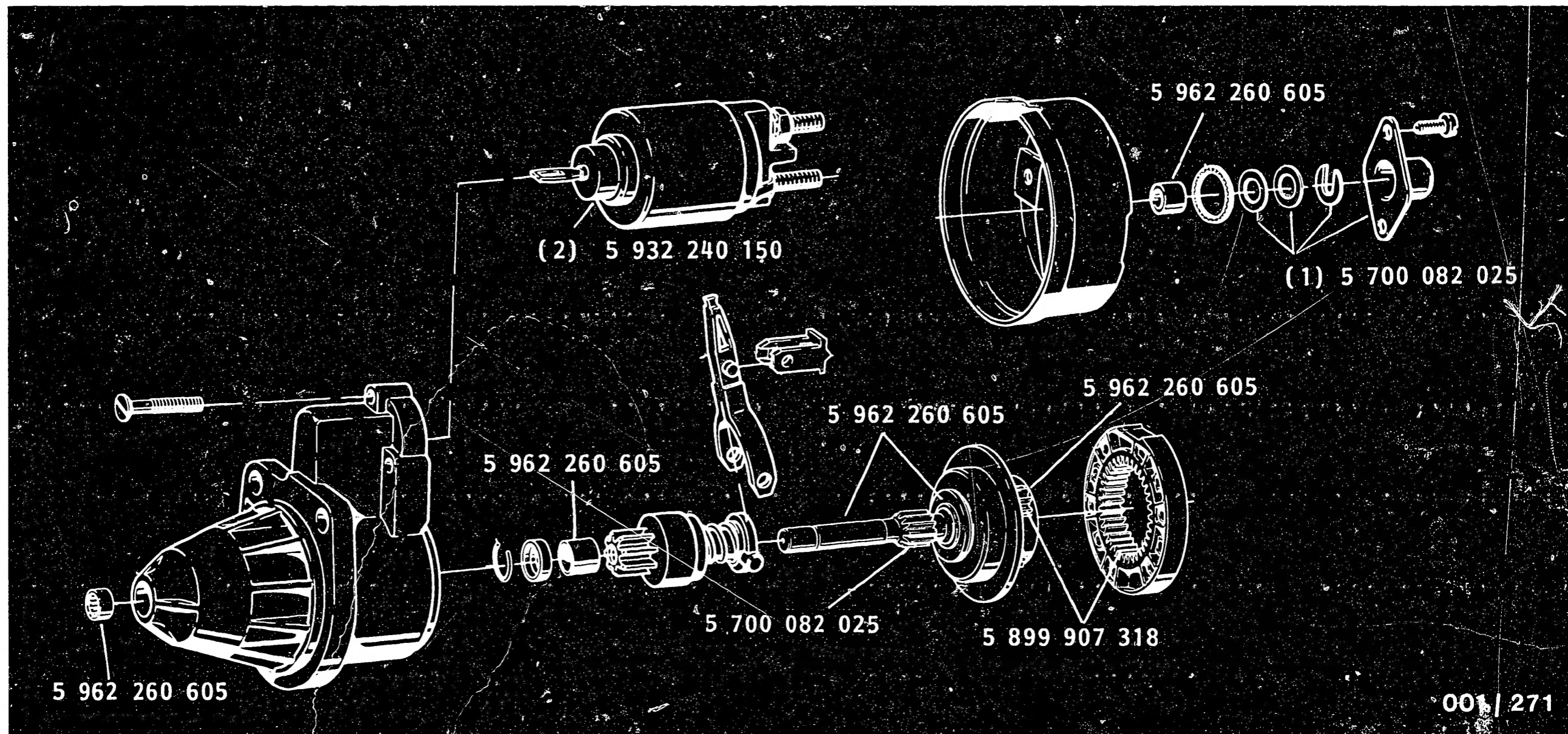

- 1 = Do not grease the inside of the holding or compensating washers or of the closure cap until after adjustment of the longitudinal play of the armature. Then grease lightly using 5 700 082 025 (approx. 0.2 g).
- 2 = 0 331 ... Grease relay armature only lightly with 5 932 440 150.

### 6.1 Lubrication table

The commutator must be kept free of grease and oil.  
 Grease or oil the indicated parts sparingly.  
 Too much grease causes malfunctions at low temperatures.  
 Lightly oil all other bare parts with anti-corrosion oil.

<b>A10</b>	Lubrication table	➔
	EV-type starting motor 0 001 218 ..	

<b>A11</b>	Lubrication table	➔
	EV-type starting motor 0 001 218 ..	

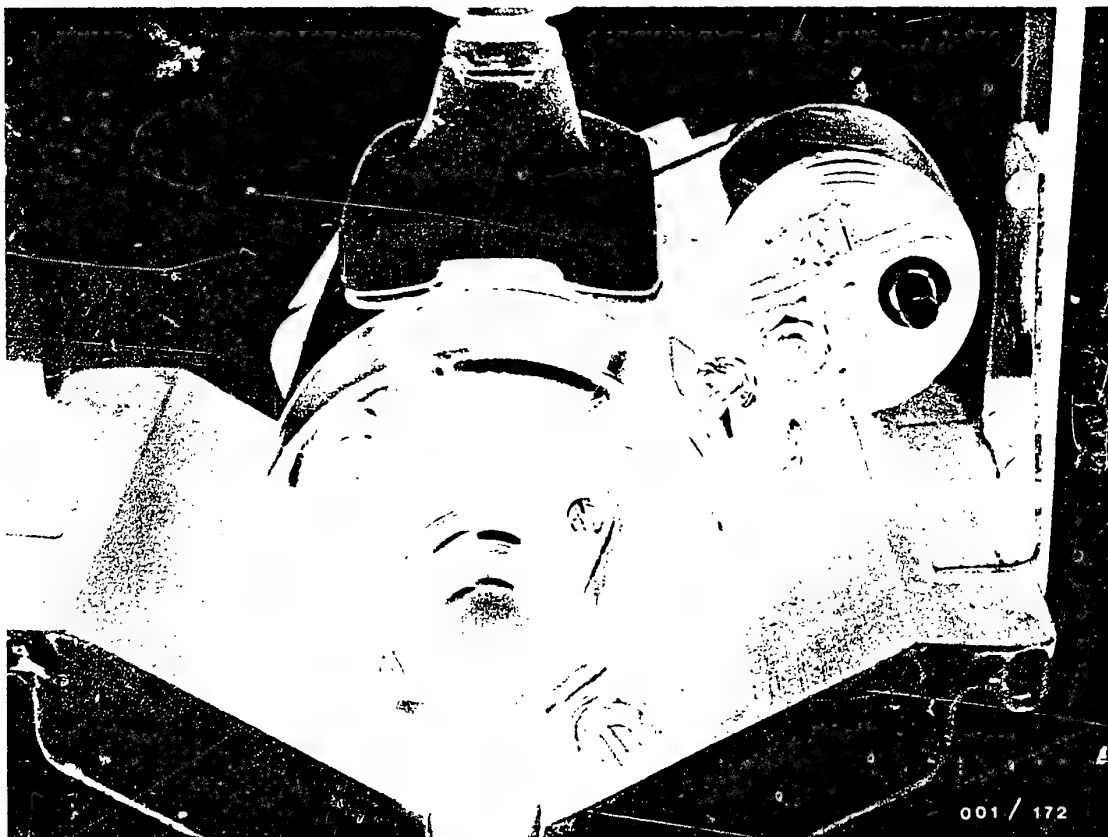

## 7. Dismantling the starting motor

- Mount the starting motor in the clamping support  
KDAW 9999

**B1**

Dismantling the starting motor  
EV-type starting motor 0 001 218 ..



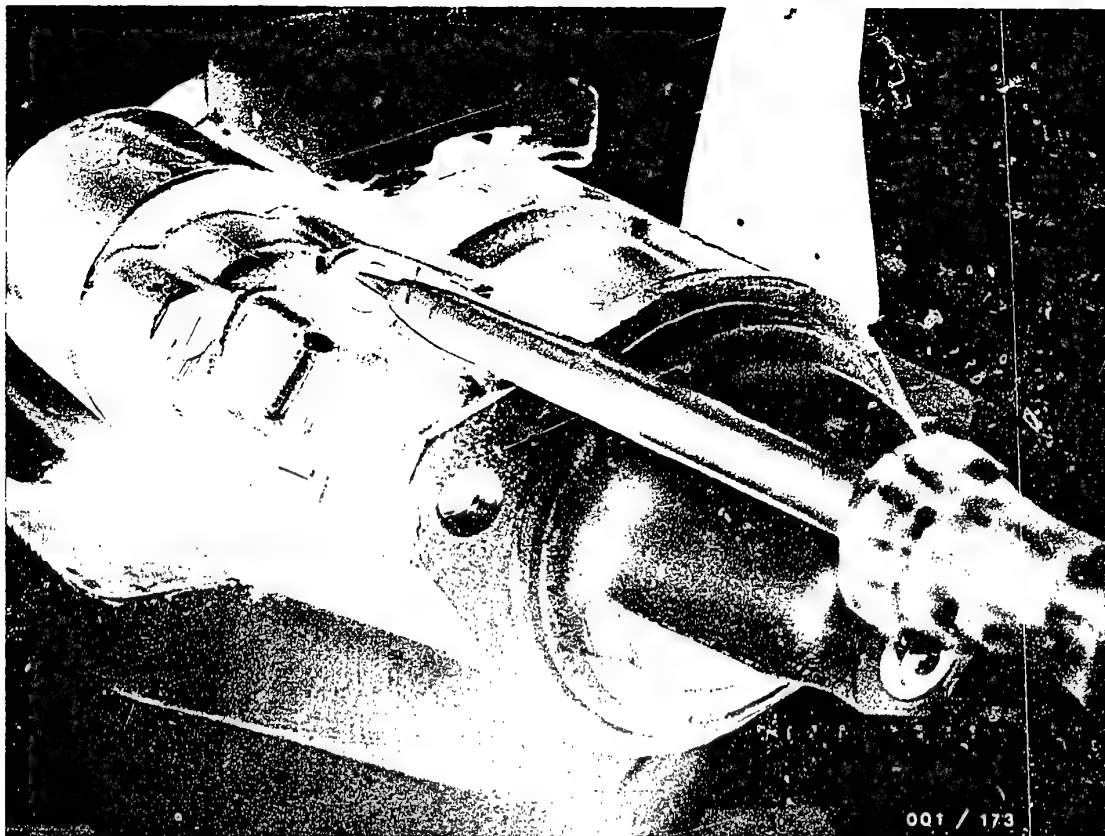

### 7.1 Removing the solenoid switch

Unscrew the nut on Term.45 on the solenoid switch.

- Unscrew term. 45 on solenoid switch.
- Loosen 3 fastening screws from solenoid switch and remove solenoid switch with armature and return spring.

**B2**

Dismantling the starting motor  
EV-type starting motor 0 001 218 ..



## 7.2 Removing the drive-end bearing housing

Screw out the through bolts.

Take off the drive-end bearing housing, including the drive shaft, free wheel, and planetary gears.

Be careful of the cover plate and the hollow wheel.

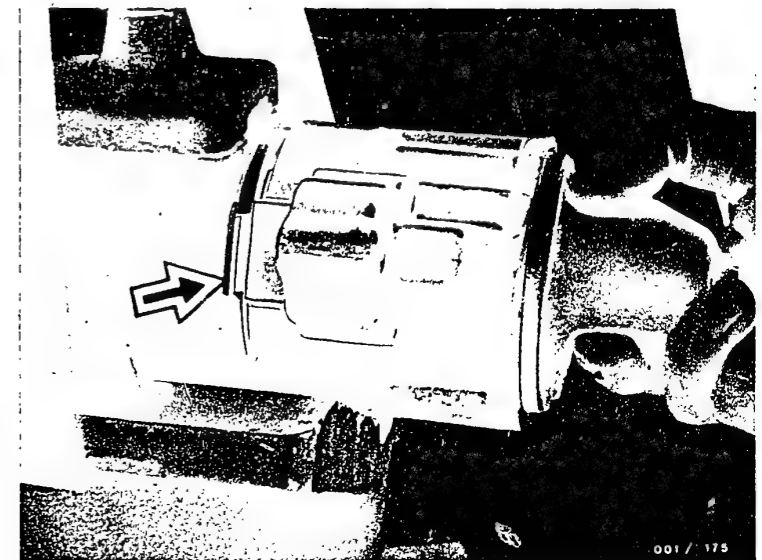
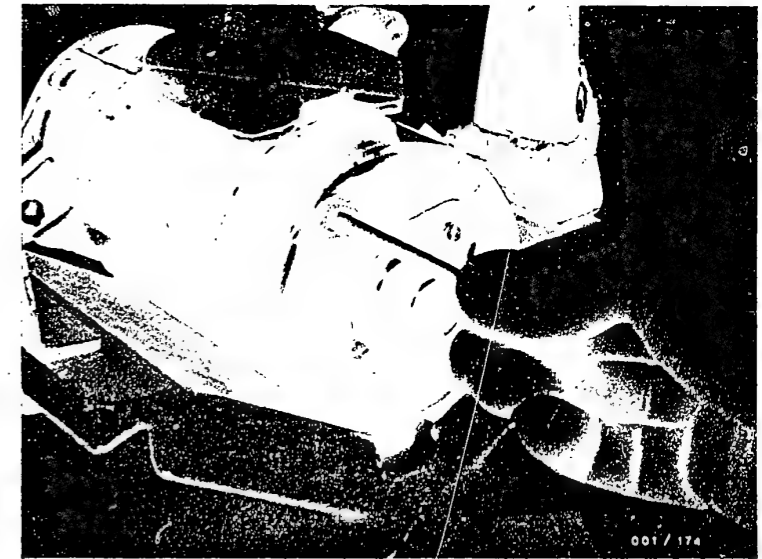

**B3**

Dismantling the starting motor  
EV-type starting motor 0 001 218 ..



**B4**

Dismantling the starting motor  
EV-type starting motor 0 001 218 ..



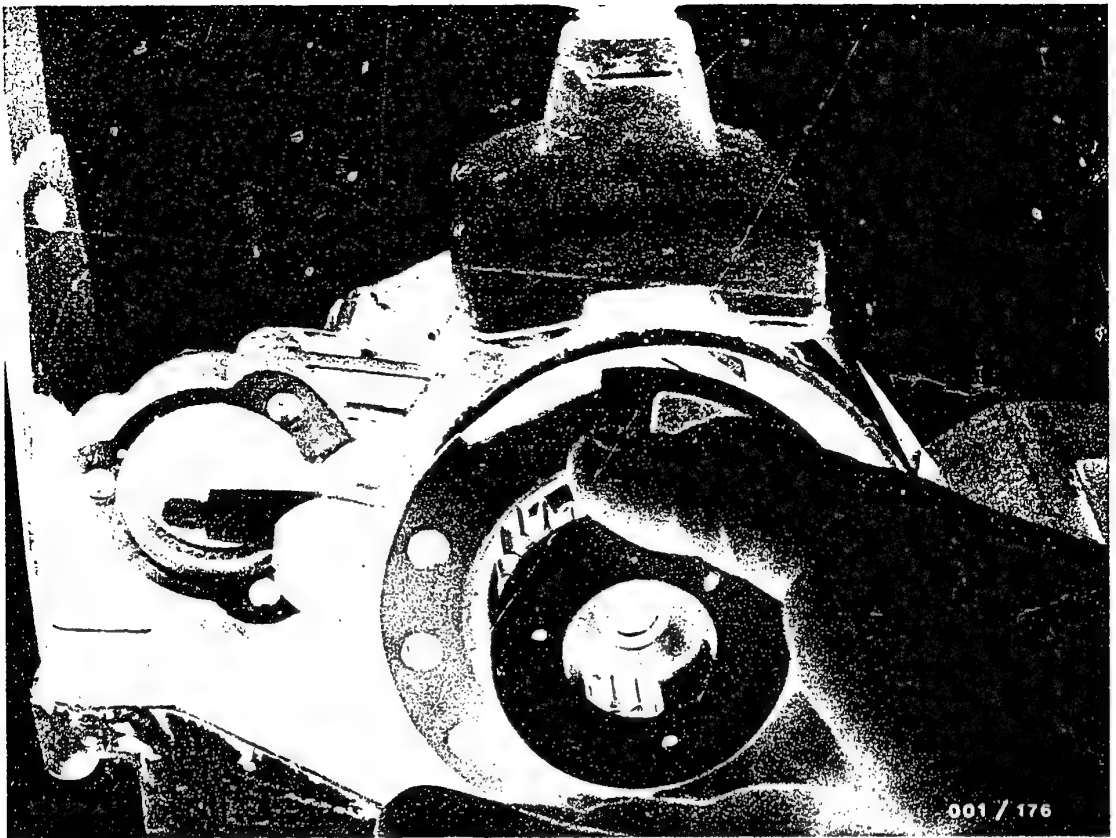

### 7.3 Taking off the free wheel and planetary gears

Mount the drive-end bearing housing in the clamping support KDAW 9999.

Take off the rubber gasket, cover plate, and the hollow wheel (already done in the Figure).

Pull the planetary gears, the free wheel, and the fork lever out of the drive-end bearing housing.

**B5**

Dismantling the starting motor  
EV-type starting motor 0 001 218 ..





In order to avoid damage, insert the planetary gears with the free wheel horizontal on assembly support KDAL 5047. Then set it up vertical.

**B6**

Dismantling the starting motor  
EV-type starting motor 0 001 218 ..



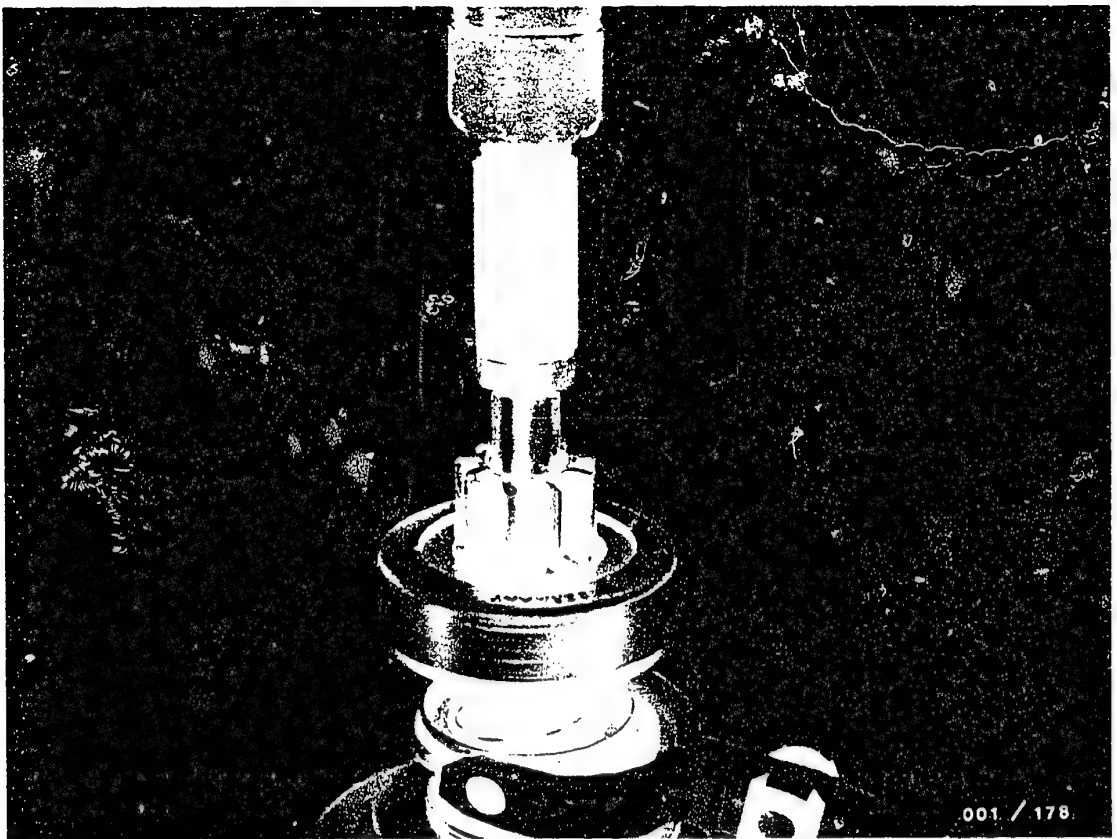

Using a striking sleeve (KDAL 5028) and a rubber hammer, push back the stop ring (Figure). Bend the ends of the lock ring far apart using a suitable pliers. When removing, avoid damage to the armature shaft. Carefully file off any burr that may be present on the slot of the armature shaft. (Otherwise there will be damage to the gear bushing).

**B7**

Dismantling the starting motor

EV-type starting motor 0 001 218 ..





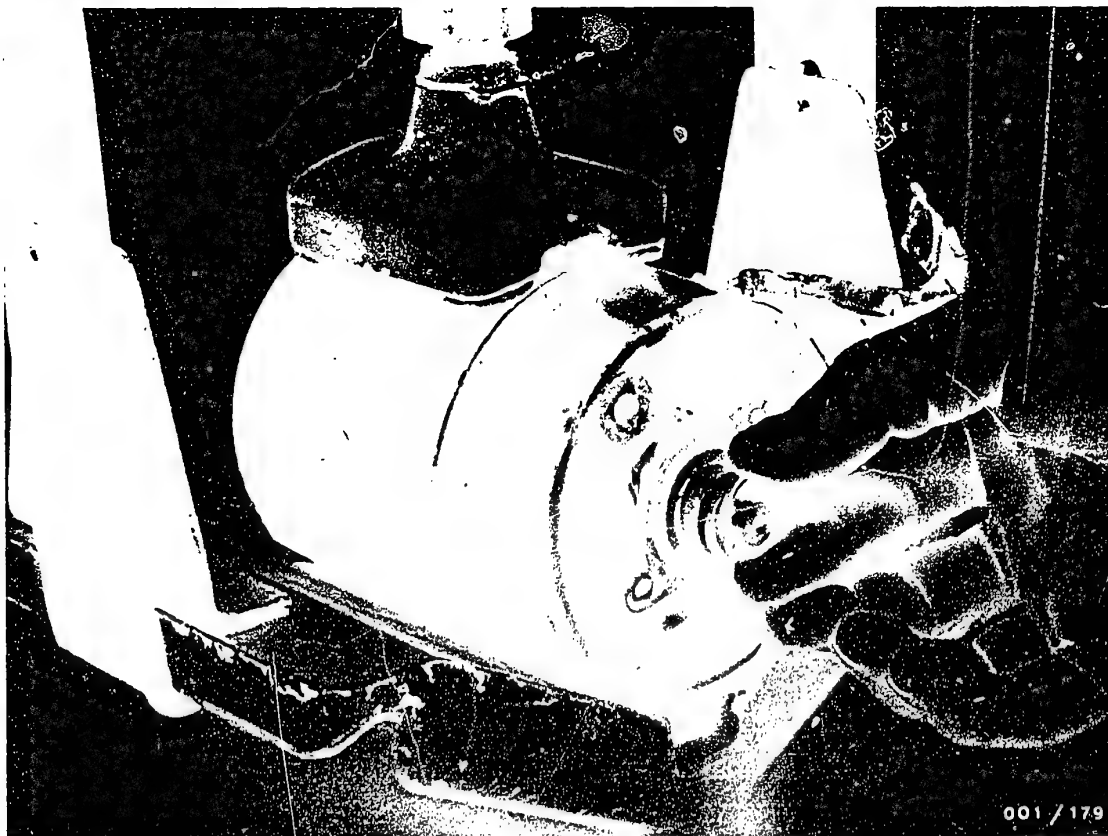

#### 7.4 Taking off the stator frame

Mount the stator frame in the clamping support KDAW 9999.

Unscrew the screws on the closure cap at the back and take off the closure cap (already done in the Figure).

Take the holding and compensating washers off the armature shaft.

Take off the commutator bearing.

**B8**

Dismantling the starting motor

EV-type starting motor 0 001 218 ..



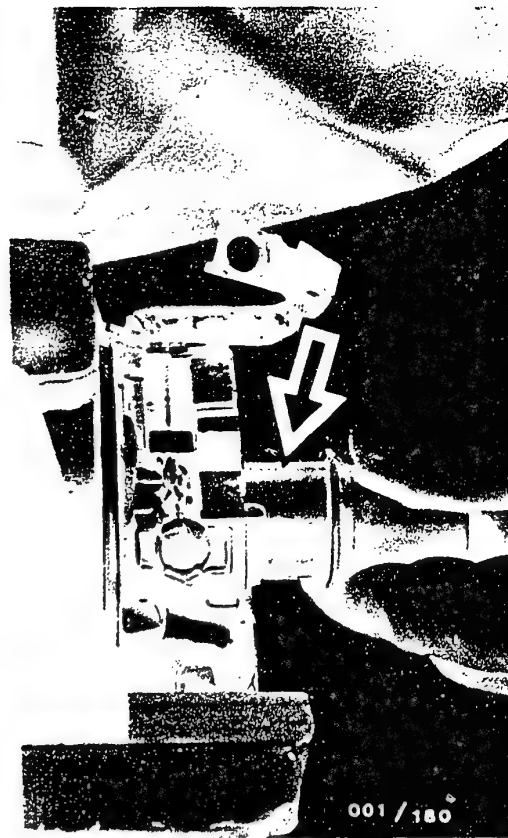

### 7.5 Taking out the armature

Put tool KDAL 5050 on the armature axle (arrow).

Carefully pull the armature out of the stator frame and at the same time, shove in tool KDAL 5050 as far as the stop in the brush holder plate (carbon brushes should touch up against the tool).

**B9**

Dismantling the starting motor

EV-type starting motor 0 001 218 ..



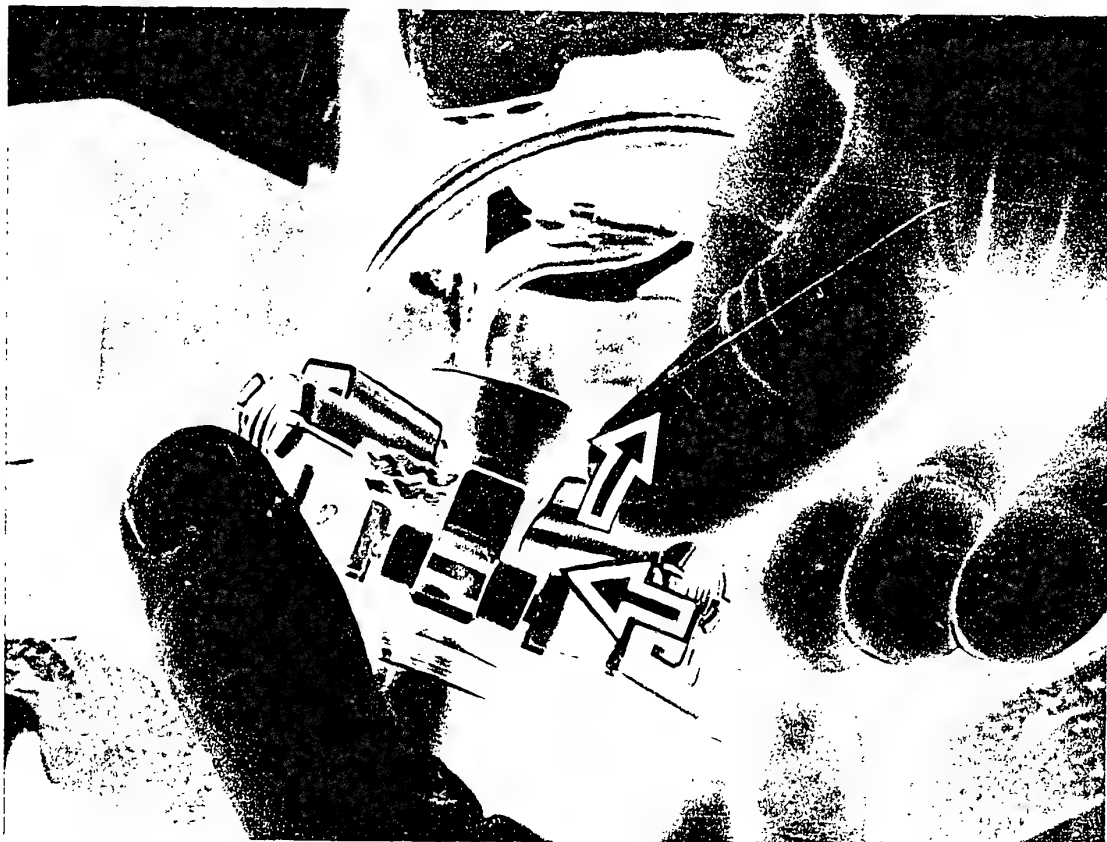

### 7.6 Taking out the carbon brushes

Take out the brush holder on the brush holder plate (see Figure).

Pull the carbon brush and the pressure spring out of the brush holder. Do not lose the pressure spring.

The connections for the exciter coils must not be disconnected from the pressure holder plate.



## 8. Cleaning the parts

Armature, windings, overrunning-clutch drive and relay must be cleaned only with compressed air (max. 4 bar) and a clean rag. Do not use liquid cleaning agent.

Other parts, such as screws and armature shaft, can be washed in low-inflammability, commercially available cleaning agent.

Do not breathe in vapours.

### Caution!

Parts which have been washed must be dried thoroughly since otherwise gases may form later in the starting motor when it has been sealed - danger of explosion-like detonation.

### Observe the following safety regulations:

Decree on Working with Combustible Liquids (Vbf) issued by the Federal Ministry of Labour (BmA).

Safety Regulations for Handling Chlorinated Hydrocarbons:

for the workshop      ZH 1 / 222  
for the employee      ZH 1 / 119

issued by the Central Association of German Employers' Liability Insurance Associations (Central Association for Accident Prevention and Industrial Medicine), Langwartweg 103, 5300 Bonn 5.

In countries outside the Federal Republic of Germany, observe the corresponding local regulations.

**B 11**

Cleaning the parts - safety regulations

EV-type starting motor 0 001 218 ..



## Working with inflammable or health-hazardous materials

Benzine, tri- or perchloroethylene are approved for the washing of motor vehicle electric components which are to be repaired.

Handle both cleaning agents carefully according to their degree of danger.

Benzine, acetone or ethanol are combustible liquids and may cause explosion when mixed with air. Washing must be performed only in special bowls or containers with fusible lids which close to automatically if the liquid ignites, thereby smothering the fire. An extractor system must be provided for larger washing vessels (as of 500 x 500 mm).

As regards starting motors, reference has already been made in earlier repair manuals to the fact that, after the parts have been washed, particularly after windings have been washed in benzine, they must be dried thoroughly.

In the case of sliding-gear starting motors, the first start after washing must be performed on the test bench without the closure cap in order to prevent detonations.



Tri and per are liquids whose vapours have a numbing effect and are hazardous to health if breathed in over long periods.

Tri vapours are heavier than air and there is, therefore, increased danger at ground level.

Wear protective goggles and gloves when washing components.

Regular or continuous cleaning operations with tri may only be performed in special containers with the extractor on.

When washing components, avoid bending over the tri container.

**B 13**

Cleaning the parts - safety regulations

EV-type starting motor 0 001 218 ..



## 9. Examination and repair

### 9.1 General

Examine all parts for wear and damage. Replace worn parts.

Before and during assembly, lubricate the starting motor as per the lubrication table.

Where necessary, lubrication points and lubricants are given in the text.

In addition, a complete lubrication table is provided on Coordinates A 10/A 11.

**B 14**

Examination and repair

EV-type starting motor 0 001 218 ..



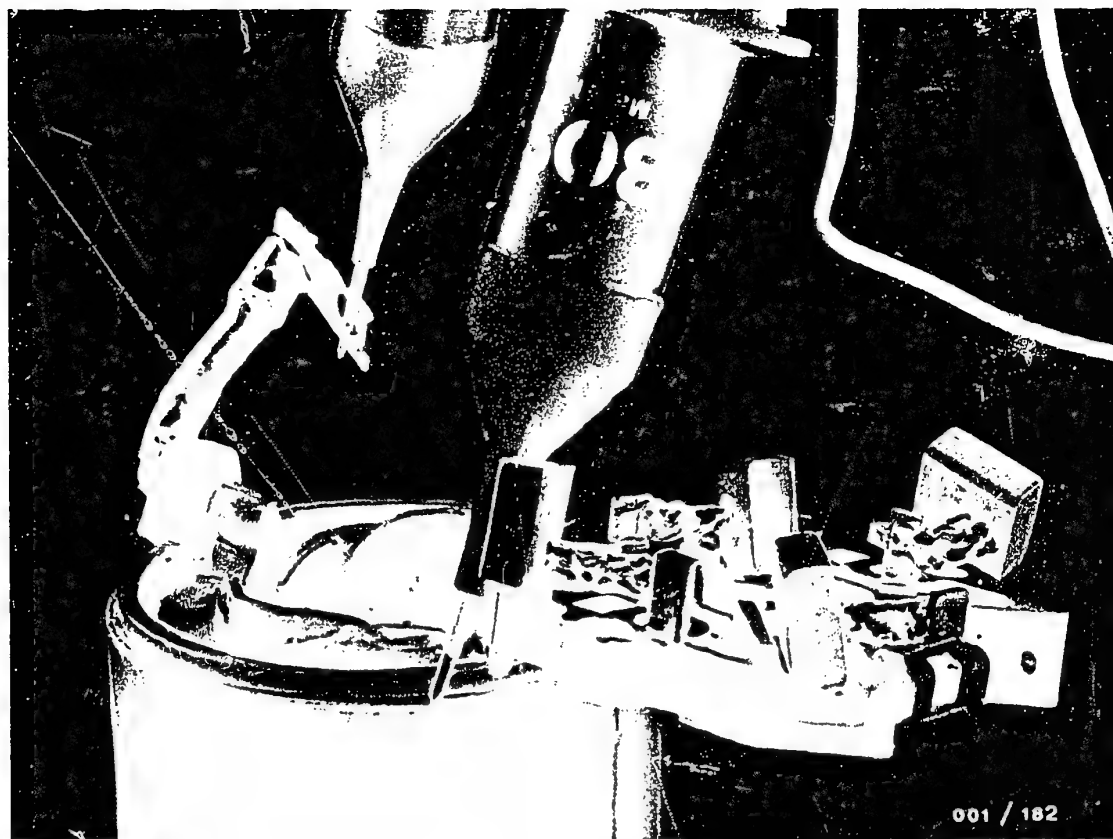

## 9.2 Testing the stator frame with excitation winding

Test the excitation winding for an open circuit using tester KDAW 9984 and KDAW 9985.

Test voltage: 6 V d.c.

Test for short circuit to ground (see illustration)

Test voltage: 80 V for 24 V starting motors

40 V for 12 V starting motors

**B 15**

Examination and repair

EV-tyne starting motor 0 001 218 ..





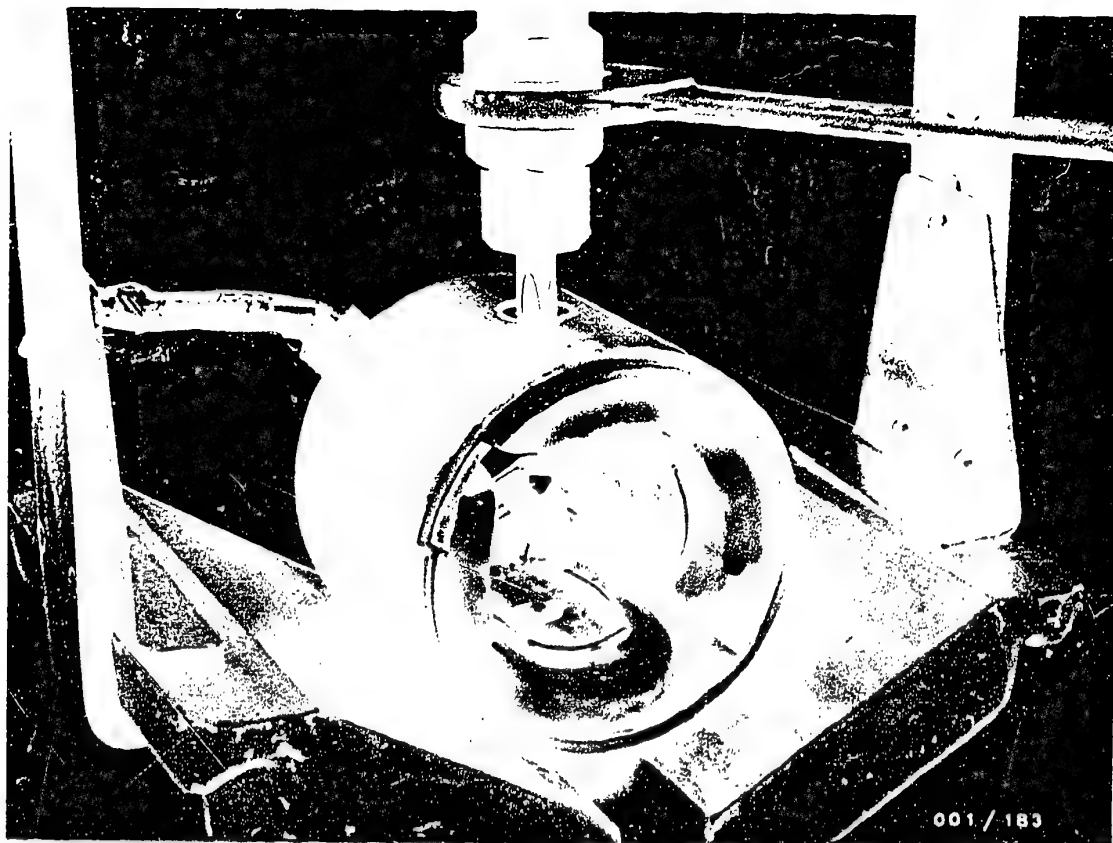

### 9.3 Taking out the exciter winding and the brush holder plate

Place the stator frame in the clamping support.  
Release the pole shoe screws (see Fig.).

Take out the windings and the brush holder plate  
together with the pole shoes.

**B 16**

Examination and repair

EV-type starting motor 0 001 218 ..



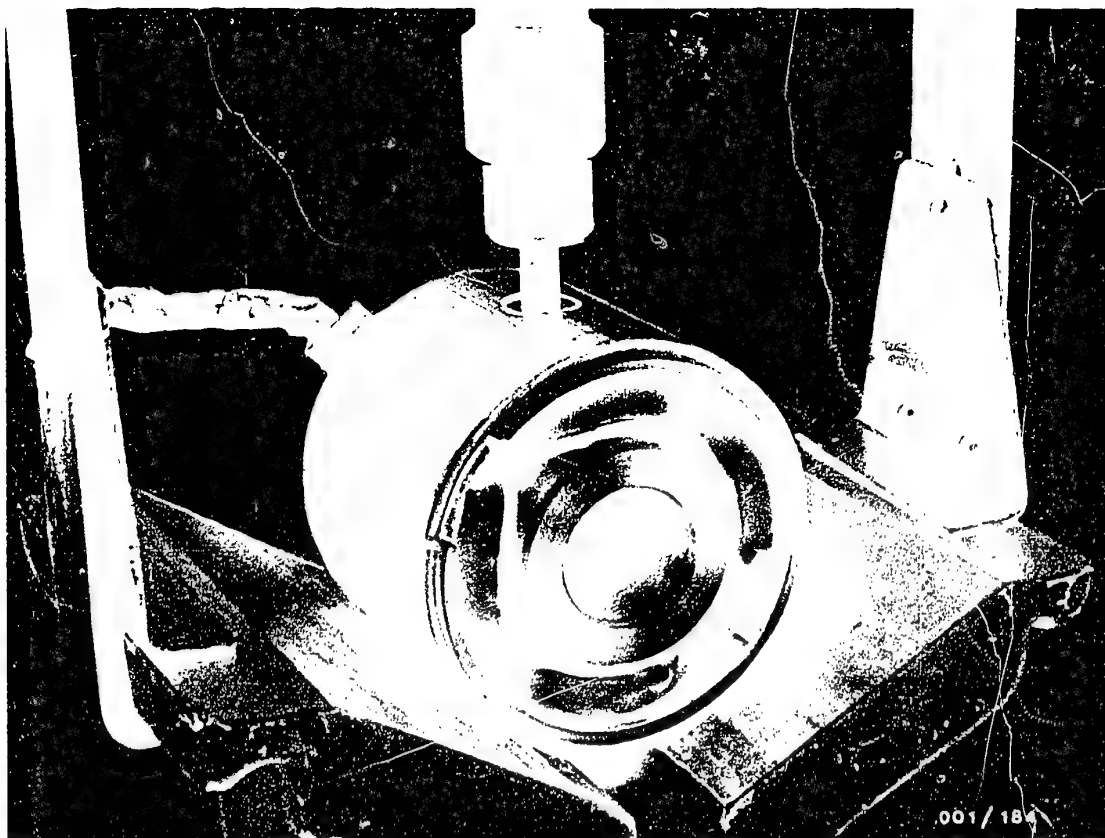

#### 9.4 Installing the exciter winding and the brush holder plate

Warm the exciter winding slightly, insert it along with the pole shoes into the stator frame and finger-tighten it.

Press in a suitable driving mandrel

$$(D = 50.7_{-0.06}^{-0.01} \text{ mm}; L = 85 \text{ mm})$$

using an arbor press (In so doing, do not damage the brush holder plate).

Place the stator frame in the clamping support and tighten the pole screw shoes. Tightening torque 38-50 Nm.

Press out the driving mandrel using the arbor press. After it is installed, check the winding again for grounding and continuity.



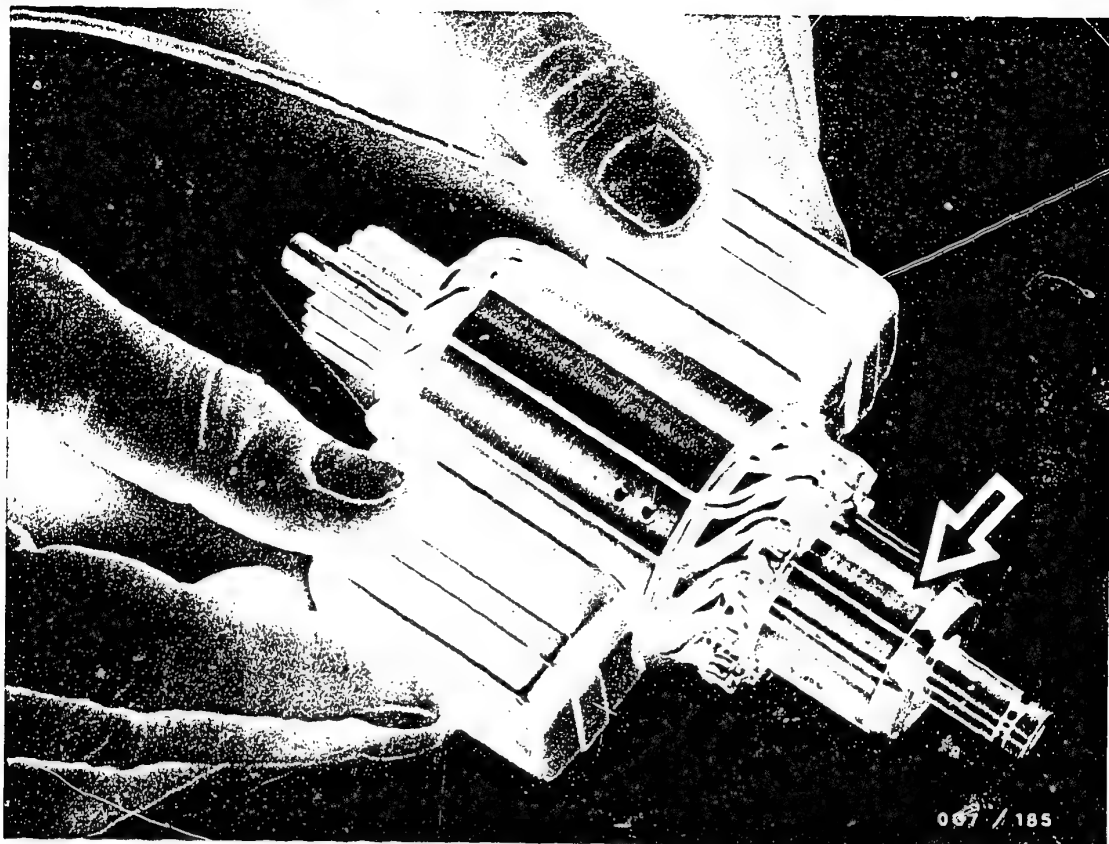

## 9.5 Examination and repair of individual parts

### Examination of armature

Check the armature for a winding short using tester EFAW 90 or EFAW 95 (Figure).

Test for short-circuit to ground using tester EFAW 81 and EFAW 82.

Test voltage:        40 V

Watch for possible open circuit (individual laminations are black - arrow).

**B 18**

Examination and repair  
EV-type starting motor 0 001 218 ..



## Turning down and undercutting the commutator

If worn points are visible on the comutator, it must be turned down.

Heavy burns indicate an open circuit - replace the armature.

Clamp the armature at the commuatator end shield and drive-end-bearing housing ends.

Do not damage the armature shaft.

### Note:

Do not clamp the armature shaft in the centre when turning down. (Centre is used in manufacture only for pre-machining the armature shaft).

### Preturning:

We recommend the use of a carbide tool.

Turn down the commutator until the worn points are no longer visible.

Commutator minimum diameter: 28.9 mm



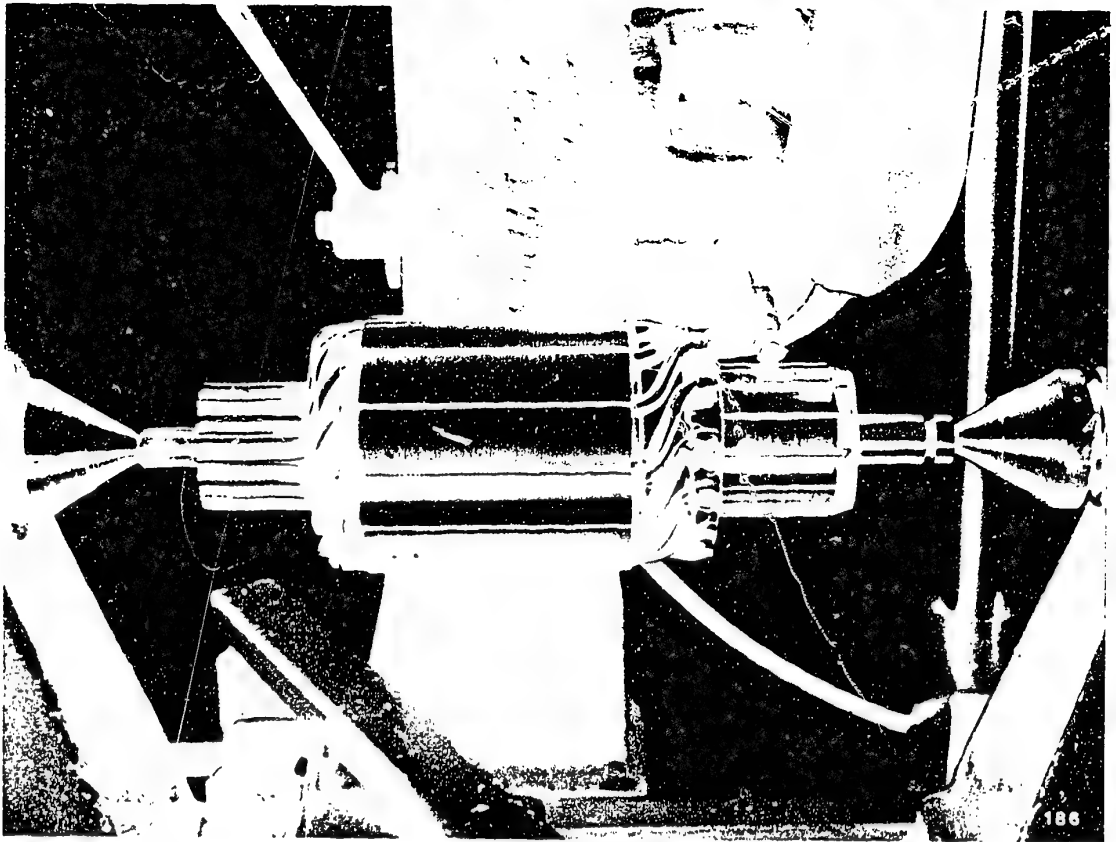

### Undercutting and finish-turning the commutator

Clamp the armature in the mount of the undercutting saw KDAW 9998. Undercut the insulation between the laminations, 0.8 mm deep.

#### Note:

The insulation between the commutator laminations contains asbestos; the dust which is released must be extracted. Health hazard.

#### Finish-turning:

Clamp the commutator in the lathe again and turn down with a fine tool.

Chips must be no more than 0.03 mm thick.

After finish-turning, brush out the commutator with a clean brush which is free of oil and grease.

**B20**

Examination and repair

EV-type starting motor C 001 218 ..



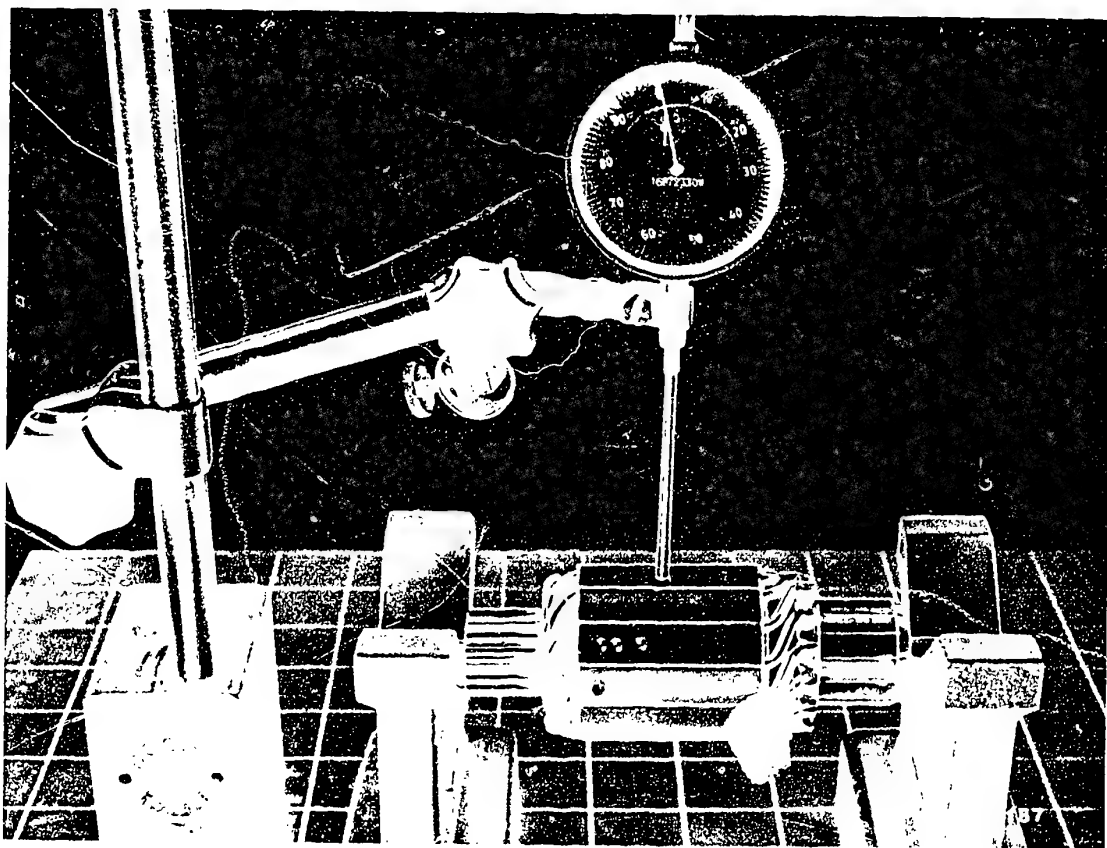

Test the true running of the complete armature

Commutator  $\leq 0.1$  mm

Laminated core  $\leq 0.5$  mm

**B21**

Examination and repair

EV-type starting motor C 001 218 ..



## 9.6 Repairing the drive-end bearing housing

Take out and replace the sintered-metal bushing and/or the needle-roller bearing in the drive-end bearing housing.

### Repair the commutator bearing.

Take and replace the sintered-metal bushing in the commutator bearing.

### Examination of the stator frame

Examine stator frame for damage (visual inspection).

If damaged, take out and replace the stator frame.

### Examination of the hollow wheel

Examine the hollow wheel for cracks and wear.



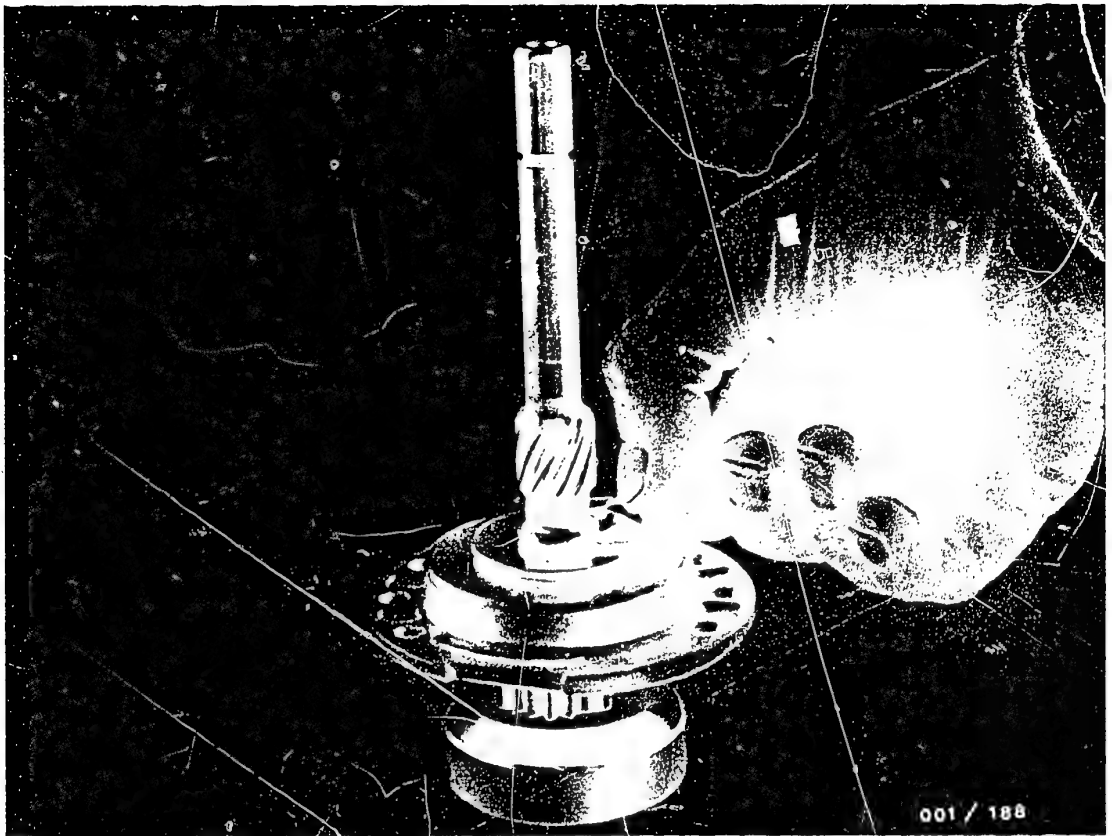

### 9.7 Examination of the drive shaft and the end shield

Release the safety locking ring on the end shield and take the end shield and the compensating washers off the drive shaft. Using the drive shaft, check the bushing in the end shield (clearance, pounding out, corners). Check the bushing in the drive shaft (bearing, armature, using measuring mandrel KDAL 5049) (no-go gauge). Put the end shield, the compensating washers, and the safety locking ring back on.

Specified value for longitudinal play in the drive shaft: 0.1 ... 0.3 mm

**B23**

Examination and repair  
EV-type starting motor 0 001 218 ..







### Overrunning-clutch drive

Unhook the fork lever (if damaged) by pulling apart the fork on the overrunning-clutch drive (see picture). Likewise separate the bearing pedestal from the fork lever.

Examine bearing bushings in drive for wear, renewing if necessary.

**B24**

Examination and repair

EV-type starting motor 0 001 218 ..



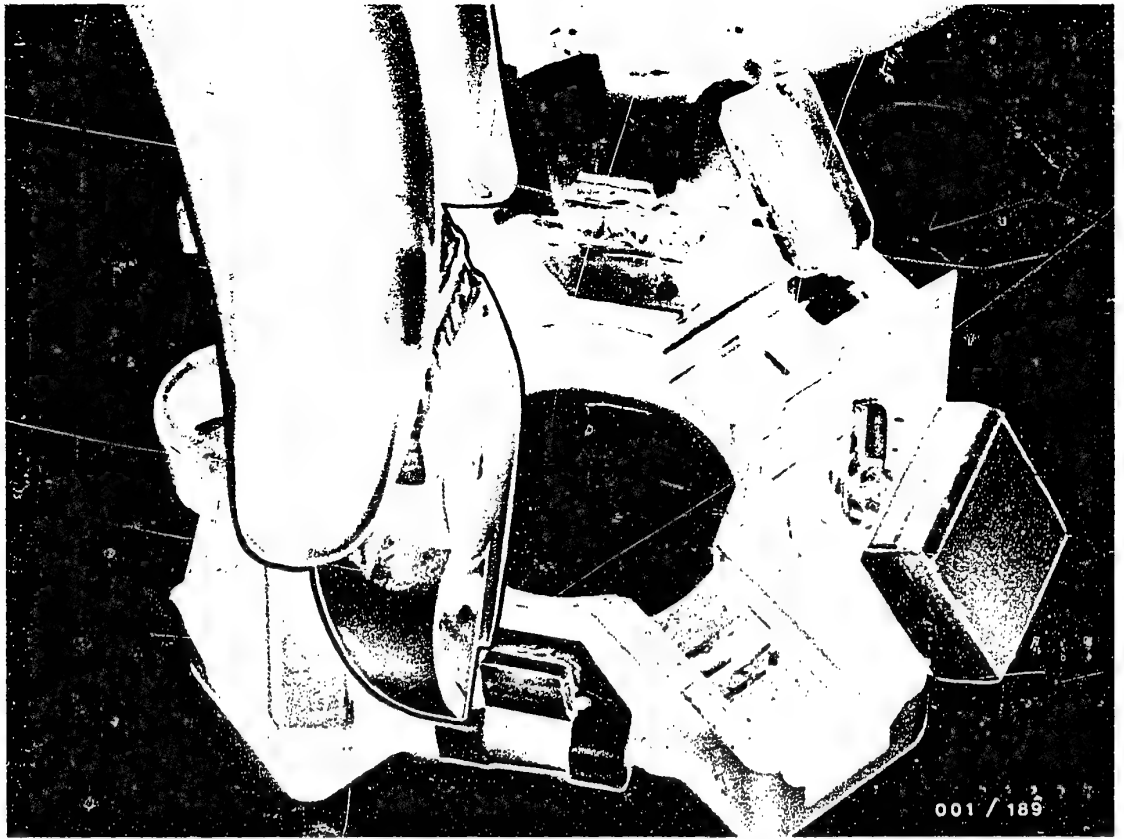

### 9.9 Taking out and replacing the carbon brushes

Minimum length of the carbon brushes 7 mm

Remove the welded-on old carbon brushes and the connecting cable (wires) (peel them off).

New service part carbon brushes are supplied with tabs welded on to the wires. These tabs are mounted on the connection rails on the brush holder and soft-soldered. Take out and replace the brush holder plate and exciter winding only as a complete unit.

**C1**

Examination and repair  
EV-type starting motor 0 001 218 ..



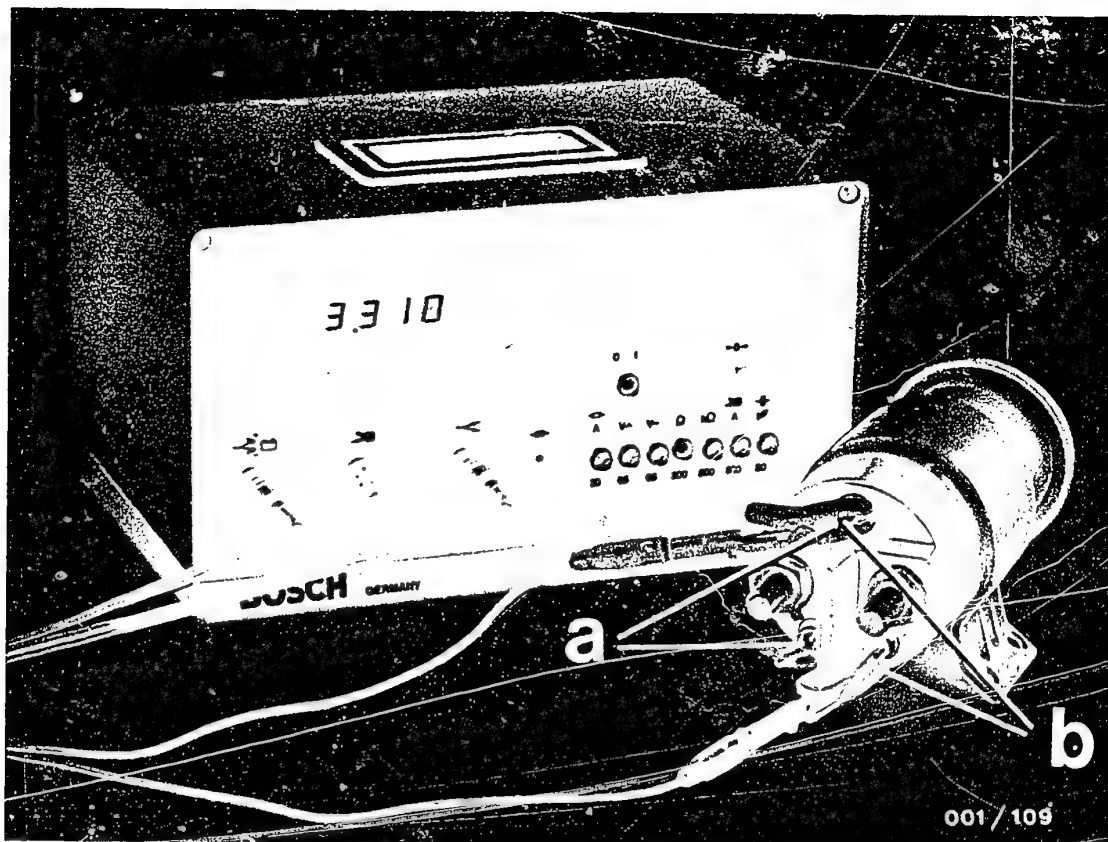

a = Pull-in winding  
 b = Holding winding

### 9.10 Testing the solenoid switch

Check for damage.

Test the resistance of the holding winding and pull-in winding (with electric tester ETE 014.00)

Holding winding

Pull-in winding

1.16 ... 1.3  $\Omega$

0.248 ... 0.281  $\Omega$

In case of functional testing, apply voltage to the pull-in winding for max. 4 seconds and to the holding winding for max. 90 seconds.

**C2**

Examination and repair

EV-type starting motor 0 001 218 ..



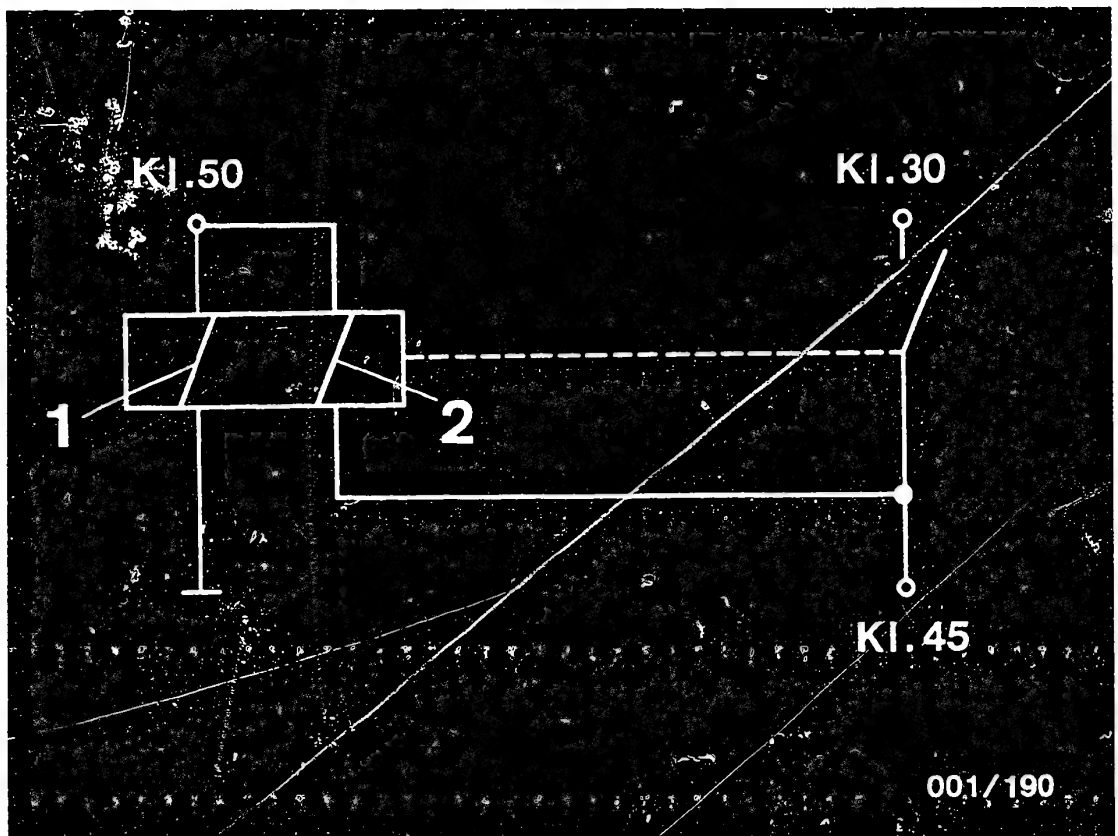

001/190

### 9.11 Examining and repairing the solenoid switch

Note:

If several solenoid switches are checked at the same time, do not mix up the solenoid armatures and springs (armature is matched to the switch).

Electrical test at approx. + 20 °C

Test position: Switch vertical, solenoid armature at top.

Note:

Solenoid armature and return spring are not rigidly connected to the solenoid switch, i.e. the solenoid armature will be flung out when testing. To prevent damage to the solenoid armature during the pull-in test, limit the cut-off movement of the solenoid armature by means of an elastic stop (hard rubber).



### Continuity and insulation test

Set the test panel to 6 V d.c. and test the windings with test prods for continuity.

Test insulated bus bars and windings for short-circuit to ground.

Test voltage for 12 V relay: 40 V a.c.

### Testing the pull-in voltage

Set voltage of approx. 3.0 V on voltage stabilizer or battery with slide resistor or similar.

Connect pull-in winding (2) and holding winding (1) as per top diagram.

Connect test lamp between + 12 V and term. 30, voltmeter between term. 50 and ground.

Fully press in solenoid armature, allow to spring out again by approx. 8 - 10 mm, and hold in this position (= "solenoid armature clearance").

Increase voltage until solenoid armature pulls in, - make reading on voltmeter.

At the same time, test lamp must light up (continuity between contacts 30 and 45). Test duration max. 2 seconds.

Specification for pull-in voltage for: 3.0 ... 6.5 V

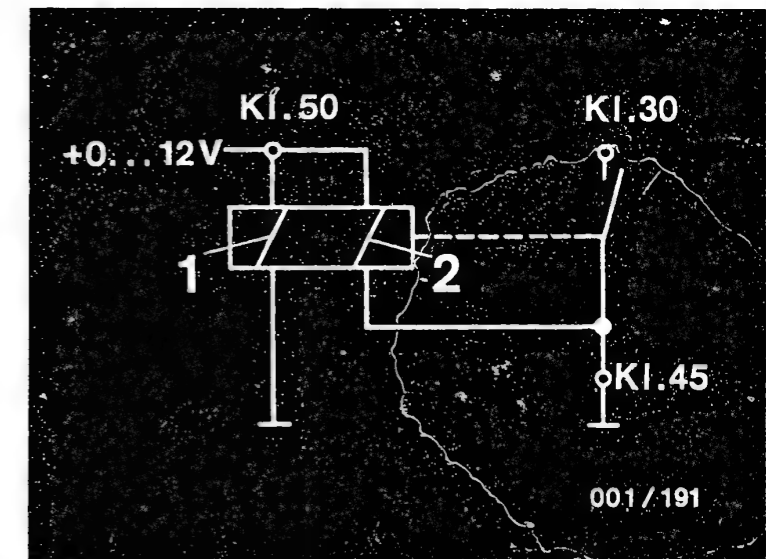

- 1 = Holding winding
- 2 = Pull-in winding
- 1 = Return spring
- 2 = Switching pin (split)
- 3 = Bridging contact member
- 4 = Terminal stud (term. 45)
- 5 = Contacts
- 6 = Contact pressure spring
- 7 = Magnetic core
- 8 = Winding
- 9 = Solenoid armature

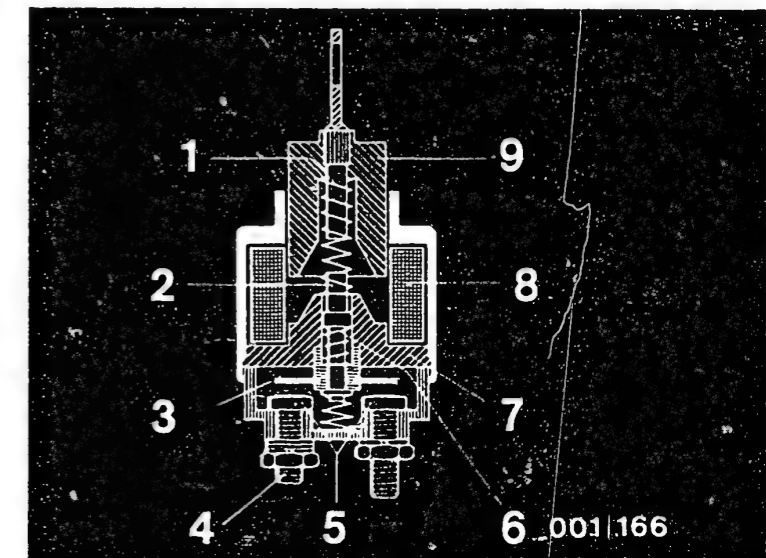

**C4**

Examination and repair

EV-type starting motor 0 001 218 ..



**C5**

Examination and repair

EV-type starting motor 0 001 218 ..



### Testing the release voltage (only with holding winding)

Disconnect the pull-in winding (2) from ground.

Press in the solenoid armature by hand, and increase the voltage until the solenoid armature is held by the holding winding.

Reduce the voltage until the solenoid armature springs out again.

Release voltage: 0.2 ... 2.0 V

### Testing the burn-off reserve

Pull-in winding (2) disconnected from ground.

Press in solenoid armature (is held only by pull-in winding (1)).

When continuity at the contacts is indicated by the lighting up of the test lamp, it must be possible to move the solenoid armature another approx. 1 mm towards the magnetic core.

### Testing the relay windings for interturn short circuit with double rated voltage (=24 V)

Apply double rated voltage to terminal stud term. 30 and ground of relay housing.

Press in solenoid armature until it rests on magnetic core.

Release solenoid armature.

Solenoid armature must automatically jump out due to pressure of return spring. Otherwise, one of the two relay windings has an interturn short circuit.

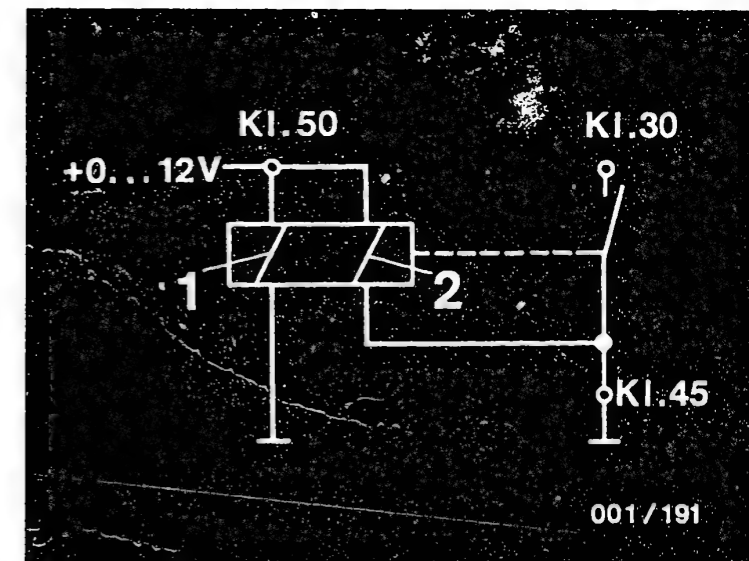

- 1 = Holding winding
- 2 = Pull-in winding
- 1 = Return spring
- 2 = Switching pin (split)
- 3 = Bridging contact member
- 4 = Terminal stud
- 5 = Contacts
- 6 = Contact pressure spring
- 7 = Magnetic core
- 8 = Winding
- 9 = Solenoid armature

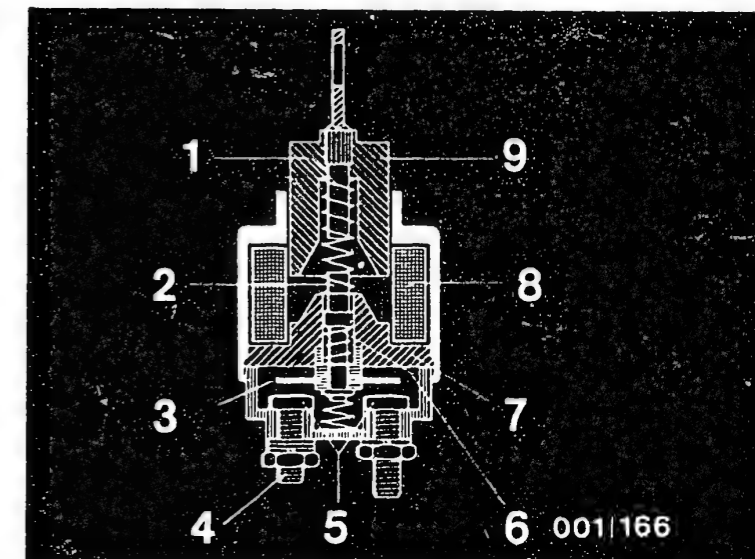

**C6**

Examination and repair

EV-type starting motor 0 001 218 ..



**C7**

Examination and repair

EV-type starting motor 0 001 218 ..



## Mechanical testing:

Burn-off reserve	0.8 ... 1.4 mm
Prestressing of the contact pressure spring	$\geq 19$ N
Prestressing of the magneto armature reset spring with approx. 9 mm armature clearance	$45 \pm 7$ N
Prestressing of the reset spring for the moving contact	$12 \pm 3$ N
Total force	$\geq 113$ N

Lightly grease the magneto armature with special lubricating grease 5 932 240 150

Under no circumstances is it permissible for grease to get on the face of the magneto core.

If too much grease is used, the grease is pressed into the switching chamber, causing contact problems.

Some of the magneto armatures are coated with a sliding laquer. If the coat of sliding laquer is no longer 100 % intact, also grease the magneto armature lightly with special lubricant 5 932 240 150.





## 10. Assembling the starting motor

### 10.11 Mounting the gear drive with overrunning clutch

Lightly oil pinion bearing surface with oil 5 962 260 605.

Lightly grease spiral spline with special lubricating grease 5 932 240 150.

Slide overrunning clutch with fork lever and bearing pedestal onto drive shaft (picture).

Slide stop ring onto armature shaft.

Using pliers, slightly open up new retainer and insert in armature ring groove.

Do not scratch armature shaft when doing this.  
Compress retainer in ring groove.

**C9**

Assembling the starting motor

EV-type starting motor 0 001 218 ..





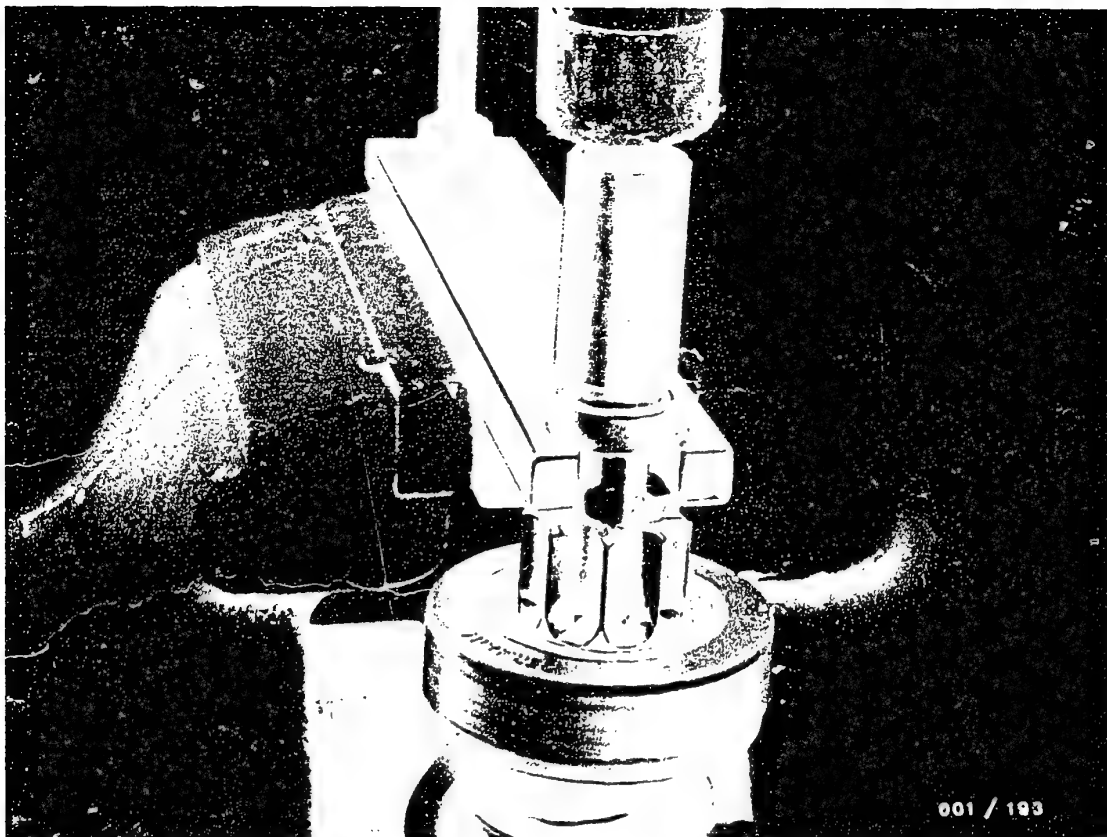

Slide mounting sleeve KDAL 5028 onto armature shaft (turned side of sleeve pointing to retainer) and calk stop ring using KDAL 5487 (picture).

Test the overrunning torque:

Free wheel  $\varnothing$  53.5 mm      Specified value: 0.14 ... 0.22 Nm

Free wheel  $\varnothing$  57.5 mm      Specified value: 0.27 ... 0.35 Nm

**C10**

Assembly of the starting motor  
EV-type starting motor 0 001 218 ..



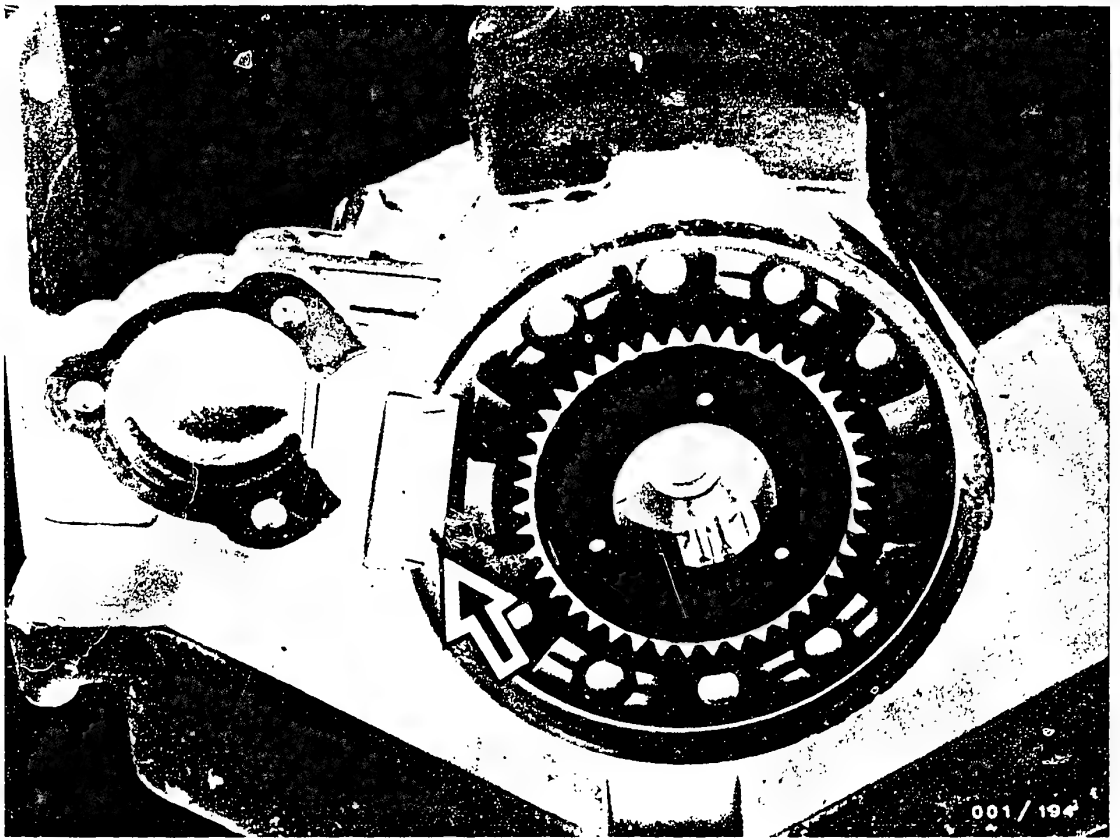

### 10.2 Putting on the drive-end bearing housing

Insert the planetary gears and the pinion, free wheel, fork lever, and bearing pedestal into the drive-end bearing housing (The recess on the hollow wheel faces the direction of the bearing pedestal/relay, see Figure).

Pull in the rubber seal (outer support for bearing pedestal, arrow).

**C11**

Assembly of the starting motor  
EV-type starting motor 0 001 218 ..



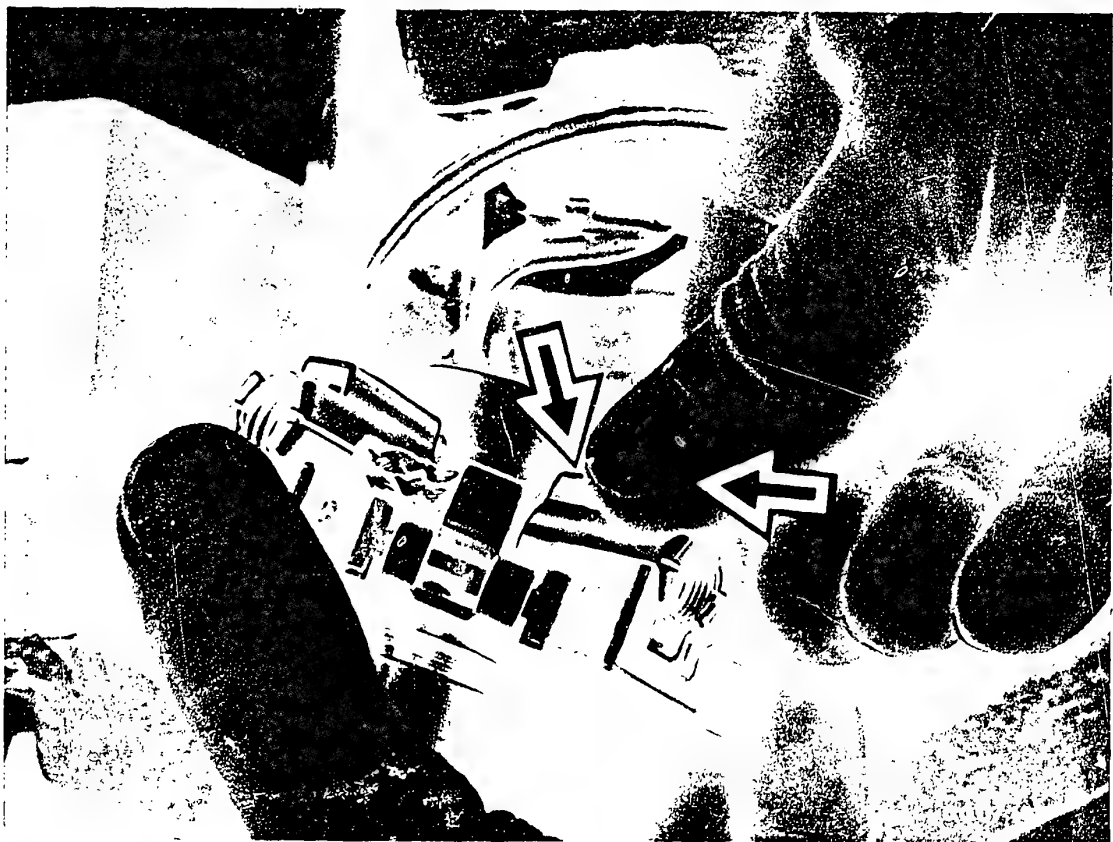

### 10.3 Insertion of carbon brushes

Insert the pressure spring and the carbon brush into the brush holder.

Insert tool KDAL 5050 into the brush holder plate. Put the complete brushholder into the brush holder plate (see Figure).



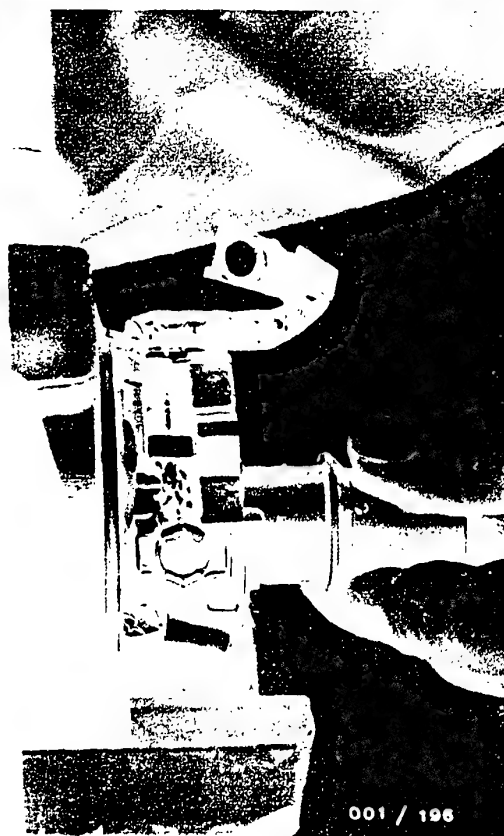

#### 10.4 Assembly of the stator frame

Carefully shove the armature into the stator frame. In so doing, simultaneously shove the brush holder plate on the commutator using tool KDAL 5050 (see Figure). The brush holder must be anchored correctly to the brush holder plate.

Fit the rubber seal on Term.45 (brush holder plate) into the slot on the stator frame.

**C13**

Assembly of the starting motor

EV-type starting motor 0 001 218 ..



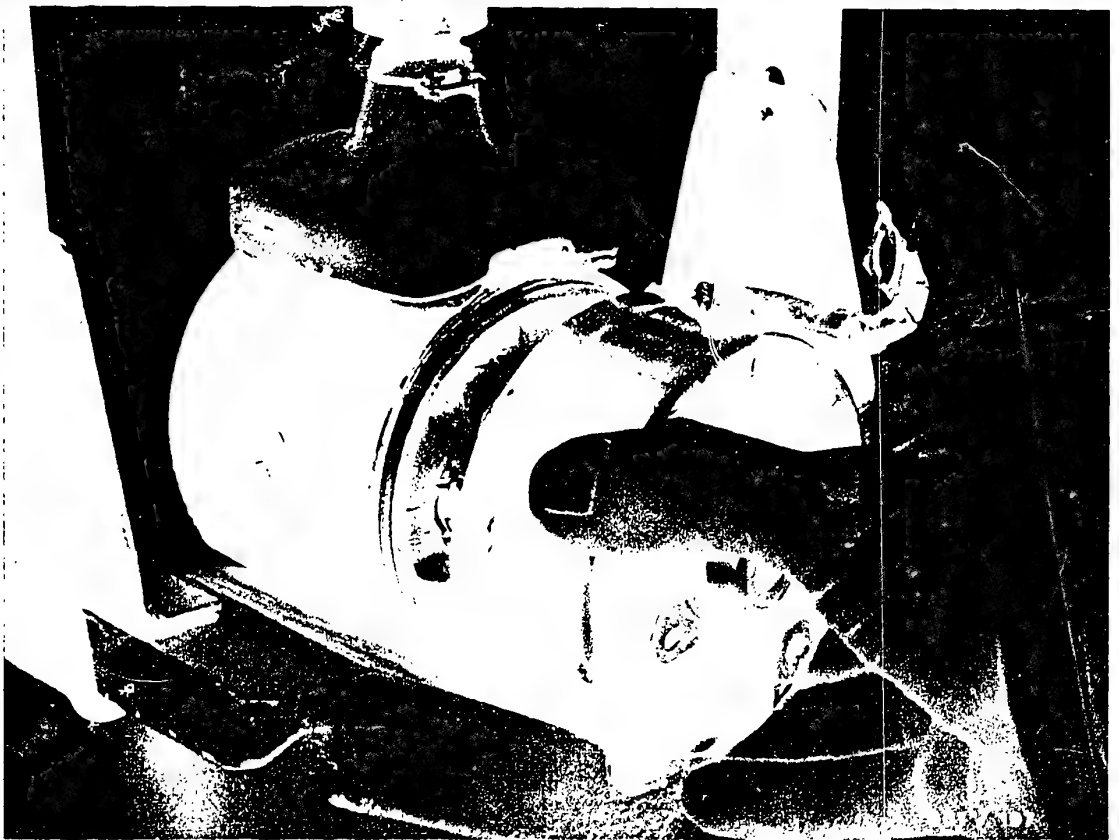

### 10.5 Putting in the commutator bearing

Put on the commutator end shield.

Shove the holding and compensating washers onto the armature shafts; adjust the longitudinal play of the armature shaft. Specified value: 0.05 ... 0.3 mm.

Grease the inside of the holding and compensating washers or the closure cap lightly with silicon grease 5 700 082 025 after adjusting the longitudinal clearance of the armature.

Tighten fastening screws for the closure cap to 1.4 ... 2.0 Nm.

**C14**

Assembly of the starting motor

EV-type starting motor 0 001 218 ..



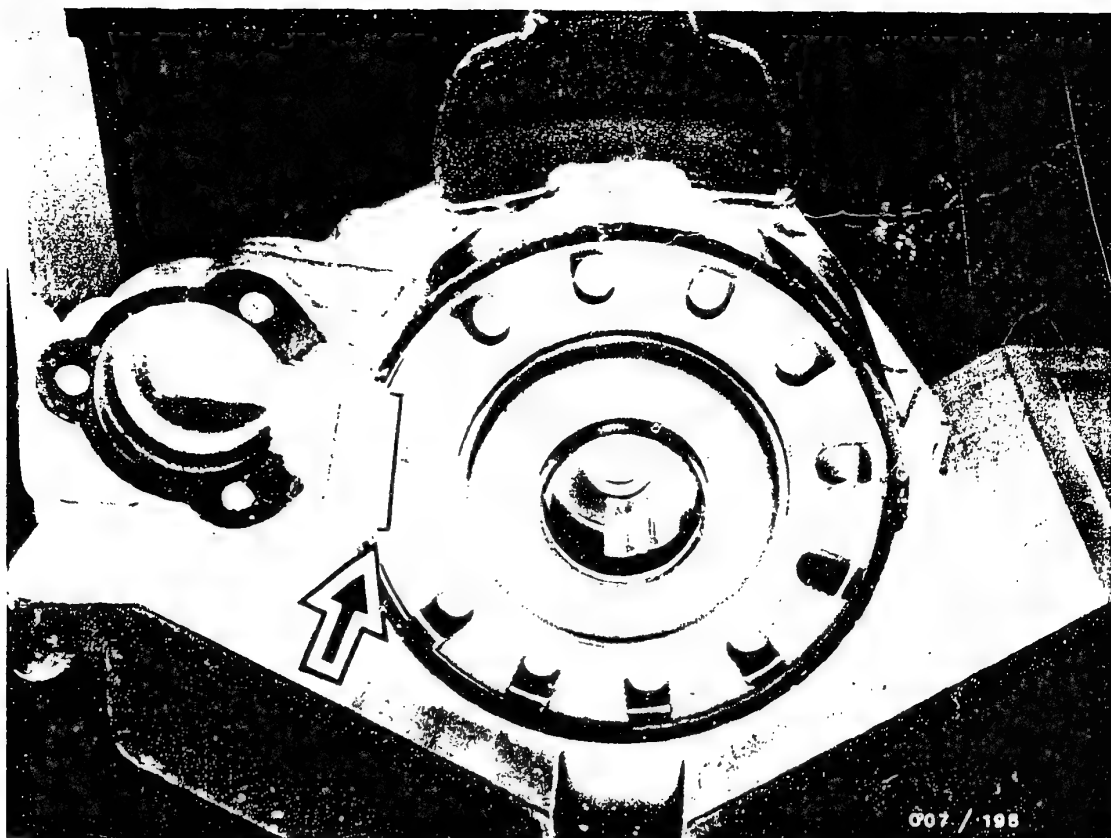

### 10.6 Putting on the cover plate

Put the cover plate on the hollow wheel in such a way that the recess on the cover plate fits the rubber seal on the bearing pedestal (see Figure, arrow).

**C15**

Assembly of the starting motor  
EV-type starting motor 0 001 218 ..



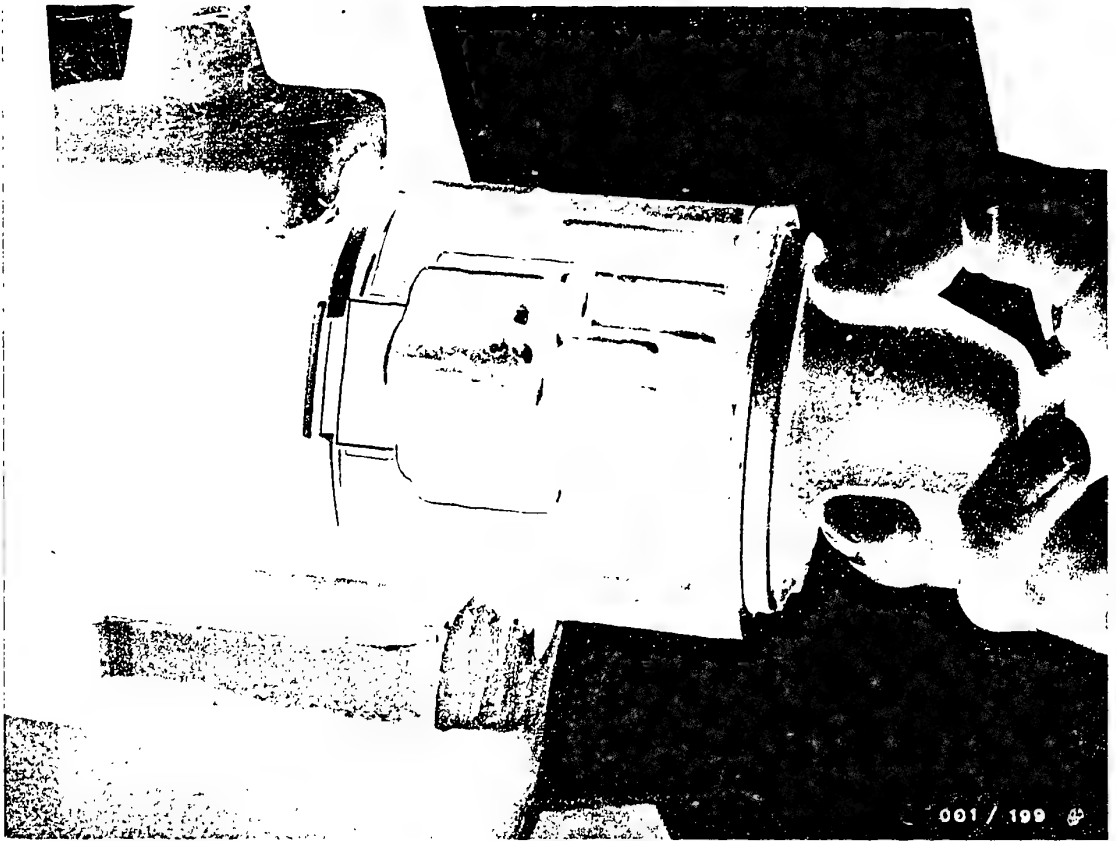

### 10.7 Putting on the drive-end bearing housing

Set the drive-end bearing housing on the stator frame. In so doing, slowly turn the pinion until the armature catches in the transmission gears; (do not use force).

The slot on the stator frame fits the rubber seal on the bearing pedestal (see Figure, arrow).

Put in the through bolts and tighten to 7.5 Nm.

**C16**

Assembly of the starting motor

EV-type starting motor 0 001 218 ..



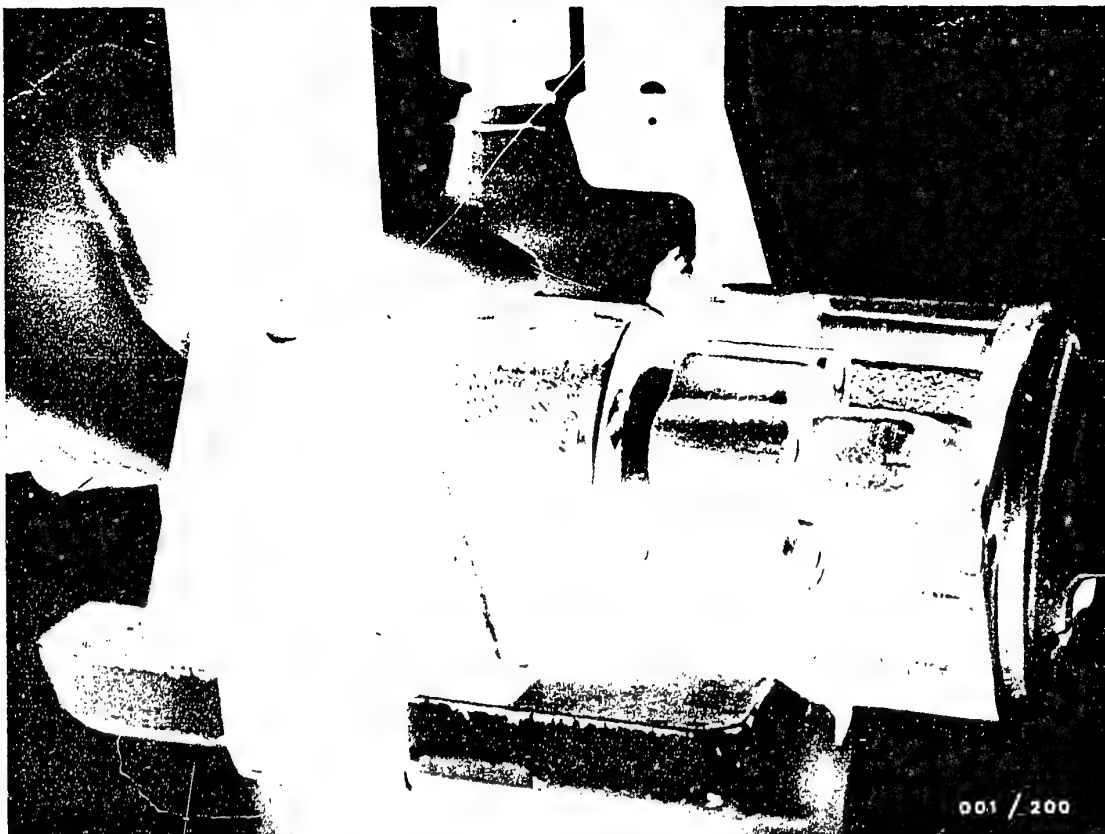

### 10.8 Mounting the solenoid-switch

Hook the solenoid switch armature into the fork lever.

Insert solenoid armature return spring and screw down solenoid switch housing.

Tightening torque for 3 fastening screws: 5.5 Nm

Mount term. 45 on relay.

Tighten nut to 9 Nm

Test the armature braking torque:

Should be 1.0 ... 1.5 Nm

**C17**

Assembling the starting motor

EV-type starting motor 0 001 218 ..





## 11. Testing on the test bench

### 11.1 General

The following test benches can be used:

EFAL 140 in conjunction with 10 m  $\Omega$  series resistor

EFAL 152 connection term. 30/2 (with series resistor)  
EFAL 153

Clamp the starting motor properly on the test bench.  
Do not mix up connections (+ to term. 30, - (ground) to housing)!!!

Connect positive and negative cables from test bench to starting motor. Tighten electrical connections (terminal studs) properly.

The electrical test specifications depend on the condition of the battery (capacity and state of charge) and the test duration (temperature of starting motor, state of discharge of battery). The test specifications apply only to the test bench and cannot be applied to starting motors which have been installed on the engine or in the vehicle. A small starting motor is more heavily loaded by the battery installed in the test bench, whereas the capacity of the test bench battery is not sufficient in the case of large starting motors to obtain the maximum output. The inevitably longer leads in the test bench also influence the output of the starting motor. Therefore, the test duration should be as short as possible and the battery should be in good condition and at least three quarters charged.

In the case of defective starting motors the measured values differ considerably from the test specifications given. In this case, dismantle the starting motor again and repeat the tests on the individual components.

**D1**

Testing on the test bench

EV-type starting motor 0 001 218 ..



## 11.2 Testing on the test bench

### Instructions:

- Do not confuse connections one for the other!
- + of the test bench to solenoid switch Term.30
- of the test bench to starting motor housing

### Testing of the solenoid switch with tooth/tooth wiring on the test bench EFAL 152/153:

Clamp in the starting motor in such a way that the pinion can be shoved forward a maximum of 2 mm.

Minimum voltage at which the solenoid switch must pull in with tooth/tooth wiring  $\leq 7.8$  V.

### Testing of the solenoid switch with tooth/tooth wiring on other test benches:

Clamp in the starting motor in such a way that the pinion can be shoved forward a maximum of 2 mm.

During the test, the + of the test bench must not be connected to Term.30 on the starting motor.

Using a voltage stabilizer (12 V approx. 25 A) or a 12 V battery with a variable resistor or a similar voltage, increase the voltage until the solenoid switch closes.

Pull-in voltage  $\leq 7.8$  V



### 11.3 No-load and short-circuit test

The test specifications are based on two 12 V/143 Ah batteries 3/4 charged with a 10 m  $\Omega$  resistor connected in series; or one 12 V/143 Ah battery with 10 m  $\Omega$  resistor in series.

#### No-load values

0 001 218 .. at 10.5 V < 160 A, >4200 min<sup>-1</sup>

#### Short-circuit test

For the short-circuit test the ring gear or tooth segment of the test bench and of the starting-motor pinion must have the same module (toothing); otherwise exchange the test-bench ring gear or set a different tooth segment.

Starting motor	Number of teeth	Module
0 001 218 001	9	2.11
003	12	2.54
004	9	2.11
005	9	2.11
006	10	2.11
008	9	2.11
009	11	2.54
014	9	3.0
015	10	2.11



## Backlash

The backlash is the gap (play) between the tooth flanks of the meshed pinion and of the ring gear/tooth segment.

To measure, mesh in the pinion manually and hold firmly, or shove the starting motor forward, and check the tooth backlash with a feeler gauge. (Not possible when the starting motor is installed in the vehicle).

Too little or too much play causes heavy wear at the teeth and can even lead to the breaking off of entire teeth.

Backlash .            Should be 0.3 ... 0.6 mm

**D4**

Testing on the test bench  
EV-type starting motor G 001 218 ..



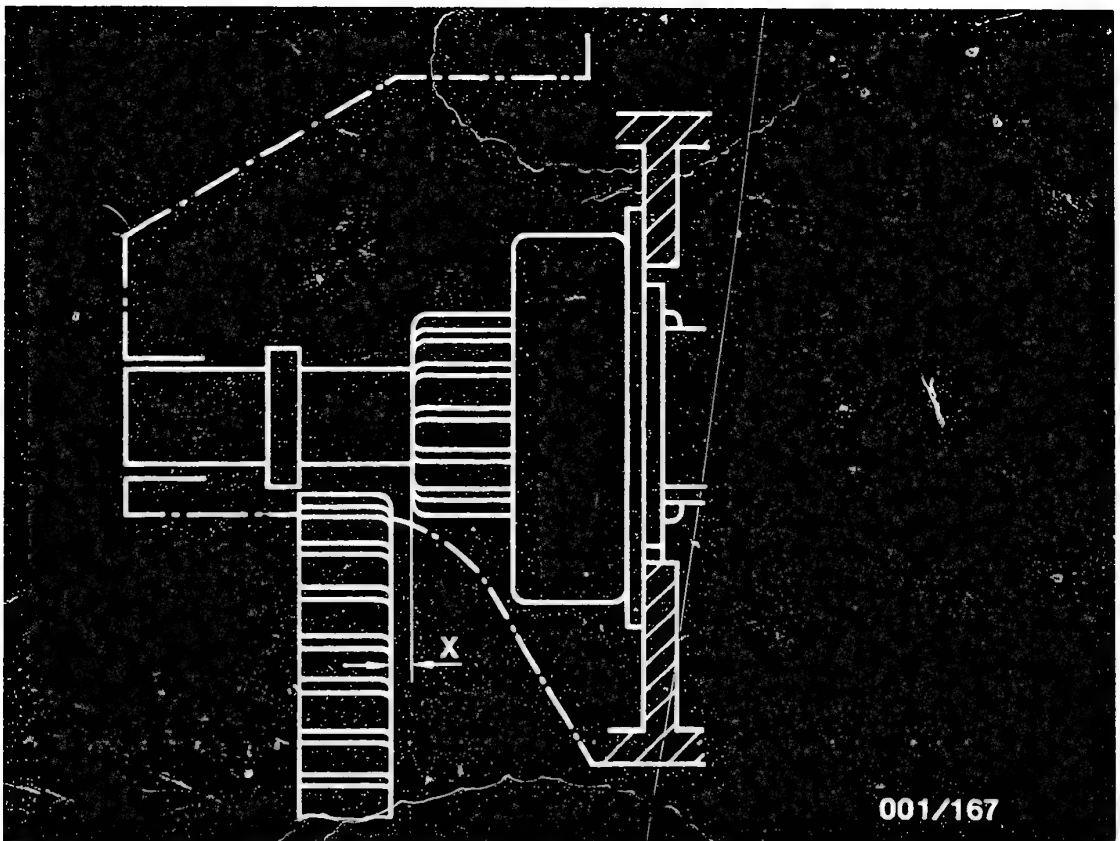

001/167

### Pinion clearance

The pinion clearance is the distance between the end face of the ring gear and the pinion end face (dimension x) with the starting motor in the rest position.

If the clearance is too great, the pinion does not mesh far enough into the ring gear; pinion teeth and ring-gear teeth have insufficient contact area and are consequently exposed to severe one-sided loading.

The minimum clearance is necessary to ensure that the pinion safely demeshes, that it does not strike against the turning ring gear in the case of heavy vibrations, and also that it does not mesh in so far that the over-running clutch impacts on the ring gear.

Pinion clearance      Should be 2.0 ... 3.0 mm

**D5**

Testing on the test bench

EV-type starting motor 0 001 218 ..



## 11.4 Test procedure

Set the measuring-range selector switch.

In the case of test benches with gear wheel/ring gear, switch on the starting motor and brake to a stop. Make readings. Perform test only briefly, max. 1 to 2 seconds.

In the case of test benches with a fixed tooth segment, briefly switch on the starting motor, make readings.

The following table gives short-circuit test specifications:

Starting motor 0 001 218 ..	V	A	Torque
Testing with 2 x 143 Ah batteries in parallel and 10 m $\Omega$ resistor in series	3.0	720...950	> 25 Nm
	2.4	580...750	> 18 Nm
Testing with 1 x 143 Ah battery and 10 m $\Omega$ resistor in series	2.8	660...810	> 24 Nm
	2.2	520...690	> 17 Nm

If the test specifications are met, the starting motor is O.K..

**D6**

Testing on the test bench

EV-type starting motor 0 001 218 ..



# After-sales Service

## Technical Bulletin

Only for use within the Bosch organization. Not to be communicated to any third party.

### Parts Cleaning

Use of highly-inflammable cleaning agents, or cleaning agents which are dangerous to health

**Gen.**

VDT-I-Gen./18 En  
7. 1978

When cleaning parts which come from vehicle electrical products prior to repair, it is permitted to use the following cleaning agents: Benzine, trichloethylene (tri) and perchloroethylene (per). These are dangerous, and must be handled with appropriate care. The relevant safety regulations in West Germany are:

Regulations concerning work with inflammable liquids (VbF) issued by the Federal Labor Ministry (BmA).

Safety regulations for the use of chlorinated hydrocarbons  
as applied to the works ZH1/222  
as applied to personnel ZH1/119

as issued by the Federation of the Trade co-operative Associations (Central Association for Accident Prevention and Industrial Medicine) Langartweg 103, D-5300 Bonn 5).

1. Benzine, acetone and ethanol (ethyl alcohol) are inflammable liquids and their mixtures with air are dangerous due to the risk of explosion. Parts washing may only take place in tanks or containers solely intended for this purpose and equipped with a "melt" safety device for the lid which, in case the liquid catches fire, causes the lid to close automatically and smother the fire. In the case of larger containers (exceeding 500 x 500mm) some form of suction extraction must be provided.

- 1.1 Generators, alternators, wiper motors, small-power motors and other electrical equipment for installation in vehicles are, in ever increasing numbers, being equipped with capacitors having long storage times (e.g. for interference-suppression purposes in radio-receiver or transmitter installations).

When washing such parts, it is possible that a capacitor discharge can occur when the part is immersed in the cleaning agent. This can lead to an inflammable liquid catching fire. For this reason, parts on which a capacitor is fitted are only to be washed in trichloethylene (tri) or perchloroethylene (per).

- 1.2 In the case of starting motors, it has already been pointed out in earlier repair instructions that the parts should be thoroughly dried after washing in benzine, this applies particularly to windings. With sliding-gear starting motors, the first test run after washing out must be performed without the closure cap in order to avoid the possibility of explosion.

**BOSCH**

Geschäftsbereich KH Kundendienst Kfz-Ausrüstung  
© by Robert Bosch GmbH D-7 Stuttgart 1 Postfach 50 Printed in the Federal Republic of Germany  
Imprimé en République Fédérale d'Allemagne par Robert Bosch GmbH

**N1**

Technical Bulletin

EV-type starting motor 0 001 218 ..



2. Trichlorethylene (tri) and perchloroethylene (per) are both liquids whose vapors have a stupefying effect, and which are dangerous to health if inhaled over long periods. Tri vapor is heavier than air, and therefore especially dangerous at floor level. Gloves and goggles are to be worn when washing out parts in these liquids.

If cleaning of parts is carried out regularly, or continuously, in trichlorethylene only containers or tanks intended solely for this purpose are to be used, and the suction extraction device is to be switched on. When washing parts do not bend over the container.





# After-sales Service

## Technical Bulletin

Only for use within the Bosch organization. Not to be communicated to any third party.

HEALTH HAZARD DUE TO ASBESTOS DUST  
Note on repair  
Extractor for undercutting (commuta-  
tor) saw

VDT-I-Gen. 043 En  
12.1981  
supersedes edition of 11.1981

Working on asbestos or products containing asbestos results in the generation of dust and minute fibers which can in the long term lead to serious damage to health.

The European Community passed a law on 28 March 1981 restricting the use of asbestos and providing for new safety regulations with regard to working with materials containing asbestos.

### Note on the repair of starting motors, generators and motors

The insulation between the commutator segments of the armatures of starting motors, generators and motors still has a high asbestos content. It is absolutely essential to extract the asbestos dust generated when undercutting this insulation with undercutting saw KDAW 9998.

As laid down in new VDI guidelines, the asbestos dust must only be extracted with an approved dirt extractor.

We therefore recommend the dirt extractor WAP-turbo M-I S-FA with the seal of approval of the German employers' liability insurance association, obtainable from

Firma Guido Oberdorfer  
WAP-Maschinen  
D-7919 Bellenberg  
Tel. 07306/5055

**BOSCH**

Geschäftsbereich KH Kundendienst Kfz-Ausrüstung  
© by Robert Bosch GmbH, D-7 Stuttgart 1 Postfach 50 Printed in the Federal Republic of Germany  
Imprime en République Fédérale d'Allemagne par Robert Bosch GmbH

**N3**

Technical Bulletin

EV-type starting motor 0 001 218 ..



As an accessory for the extractor we offer the stand KDAW 9998/20 which can be used for securing the suction tube with nozzle (see sketch).

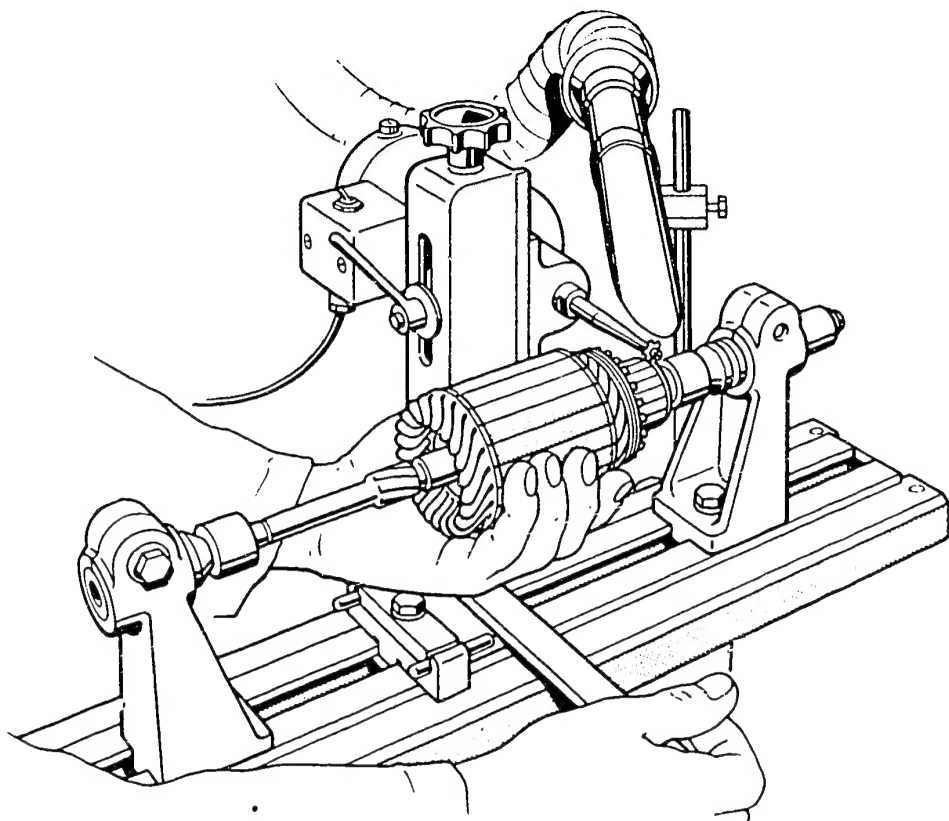

Please direct questions and comments concerning the contents to our authorized representative in your country.

**N4**

Technical Bulletin

EV-type starting motor 0 001 218 ..



# After-sales Service

## Technical Bulletin

Only for use within the Bosch organization. Not to be communicated to any third party

INTERMEDIATE-TRANSMISSION STARTING MOTOR WITH  
EPICYCLOIDAL GEAR TRAIN AND PERMANENT-MAGNET  
EXCITATION.

VDT-I-001/131 En  
4.1982

0 001 108 .. DW 12 V 1.1 kW

The newly developed type of starting motor with epicycloidal intermediate transmission and permanent-magnet excitation is being introduced as original equipment in 1982 (see Technical Bulletin "New product" VDT-I-001/1 for information on the starting motor).

First application: AUDI 100 2.2 l, 5-cyl. engine  
AUDI 200

It should be noted that in comparison with the previous starting motor, the DW starting motor is, because of its construction, sensitive to impact, shock and pressure and may only be clamped by its flange when testing.

Until further notice, please send in all complaint starting motors of the new type unopened together with the usual warranty documents and stating the reason for the complaint.

From inside Germany to:

ROBERT BOSCH GMBH  
Abteilung K9/VAK 2  
Robert Bosch-Straße  
7141 Schwieberdingen

From outside Germany through KG/AV to:

ROBERT BOSCH GMBH  
Abteilung KH/LAV  
Auf der Breit 4  
D 7500 Karlsruhe 41  
zur Weiterleitung an K9/VAK 2

The intermediate-transmission starting motor (Part No.: 0 001 108 001/..002) can - insofar as it is not in stock - be replaced by the after-sales service by the previous starting motor version 0 001 311 140.

In case of inquiries, please contact your local representative.

**BOSCH**

Geschäftsbereich KH Kundendienst, Kfz-Ausrüstung  
© by Robert Bosch GmbH, D-7 Stuttgart 1, Postfach 50. Printed in the Federal Republic of Germany.  
Imprimé en République Fédérale d'Allemagne par Robert Bosch GmbH.

**N5**

Technical Bulletin

EV-type starting motor 0 001 218 ..



# T A B L E O F C O N T E N T S

<u>Section</u>	<u>Coordinate</u>
Structure of microfiche .....	A 1
1. Test specifications - electrical .....	A 2
2. Test specifications - mechanical .....	A 3
3. Terminal diagram and circuit diagram ...	A 4
4. General information .....	A 5
5. Test equipment and tools .....	A 7
6. Lubricants, lubrication table .....	A 8
7. Dismantling the starting motor .....	B 1
8. Cleaning the parts .....	B 11
9. Examination and repair .....	B 14
10. Assembling the starting motor.....	C 9
11. Testing on the test bench .....	D 1
Technical Bulletin .....	N 1

©1984 Robert Bosch GmbH  
Automotive Equipment - After-Sales Service,  
Department for Technical Publications KH/VDT,  
Postfach 50, D-7000 Stuttgart 1

Published by: After-Sales Service, Department for  
Training and Technology (KH)VSK) - Press date: 7.1984

Please direct questions and comments concerning the  
contents to our authorized representative in your  
country.

This publication is only for the use of the Bosch  
After-Sales Service Organization, and may not be passed  
on to third parties without our consent.

Microfilmed in the Federal Republic of Germany.  
Microphotographié en République Fédérale d'Allemagne.

**N24**

Table of contents / Impressum

EV-type starting motor 0 001 218 ..

